

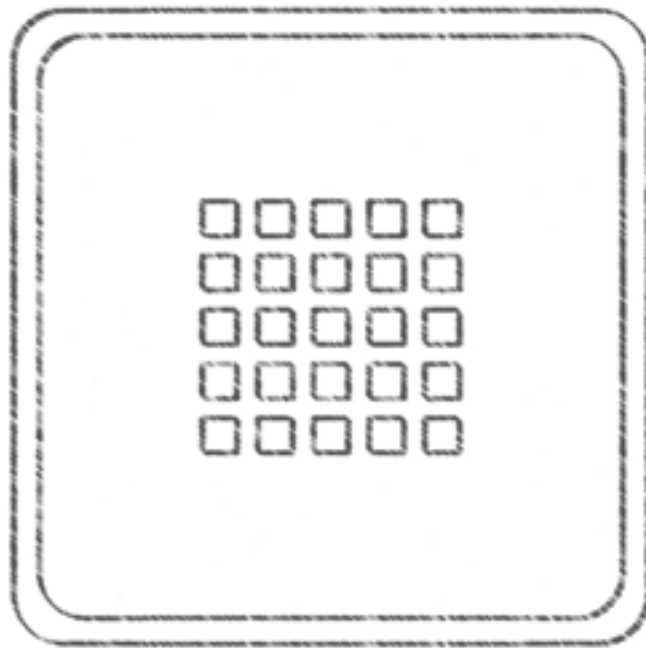

venture

STONE PLUS COLLECTION



SHOWER BASES

USA · CANADA

INDEX

ABOUT US	00
STONE COLLECTION PLUS	00
STONE COLLECTION SIDE	00
STONE COLLECTION MIO	00
STONE COLLECTION CACH	00
STONE COLLECTION SMART	00
STONE COLLETION SORTY	00
STONE COLLECTION 3D	00
WALL PANEL	
OHU: BATHROOM ACCESORIES	
INSTALLATION MANUALS	
WARRANTY	

MINIMALIST
DESIGN
INTERIOR
CONCEPT

ABOUT US

Duplach Group is a duly established company born in 2010 focused on the creation and manufacture of shower bases made with resin, mineral fillers and Gel Coat. Duplach also produces bathroom shower panels, bathroom accessories and bathroom furniture made from wood, melamine and a 3D print finishing.

Duplach Group has achieved its international growth goals with a positioning strategy in more than 20 countries within the EU, Africa, The UK, U.S.A and Canada.

From our modern 10 000 square meters facilities, at Duplach Group we produce shower bases and bathroom furniture with the most innovative machinery. A breakthrough and modern company, meeting the highest standards of quality: cUPC, ISO 9001 certified quality and is environmentally friendly according to ISO 14001 certification.

Our productive capacity allows us to give the most demanding requests response, being clients our greatest value. Faithful to Kaizen philosophy, our goal is continuous improvement.



DUPLACH GROUP S.A.U.
DUPLACH PLATO DE DUCHA
(Nº DdP-01)
UNE EN 14527-2006 + A1:2010
USO DOMÉSTICO, PARA LA HIGIENE PERSONAL



EFQM
QUALIFIED BY
EFQM 2022



STONE COLLECTION
PLUS

The Stone PLUS model stands out for a neat design line and its square shape grid. Such a simple and stylish shower base.



DUPLACH GROUP S.A.U.
DUPLACH PLATO DE DUCHA
(Nº DGP-01)
UNE EN 14527:2006 + A1:2010
USO DOMÉSTICO, PARA LA HIGIENE PERSONAL



EFQM
QUALIFIED BY
EFQM 2022











INFORMATION

COLORS

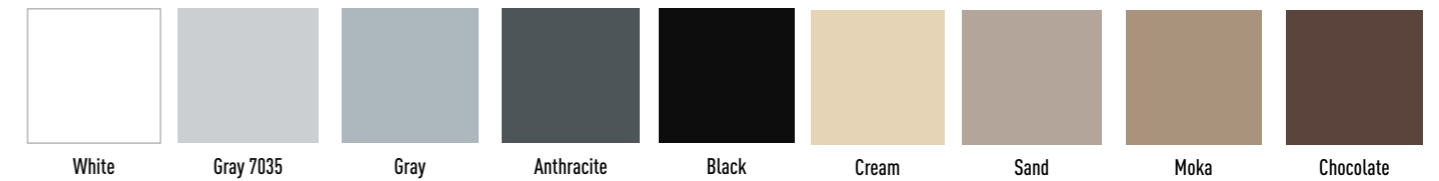

Manufacturing comes with a colored mass as from our color chart. Shower bases produced in any different color within the RAL chart entail a subsequent price increase. Products made with colors other than our color chart ones can not be returned.

TEXTURES



SMOOTH

SLATE

GRIDS INCLUDED IN PRICE

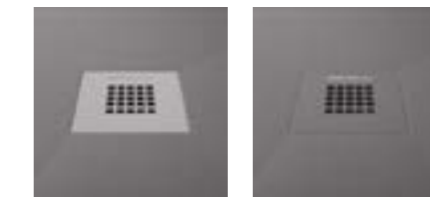

STAINLESS STEEL GRID

COLOR GRID

Stainless steel or painted to match color of the base (brushed stainless steel finish optional)

SHOWER DRAIN



For 2" connection, meeting with the cUPC standards. Included in price

CUSTOMIZABLE

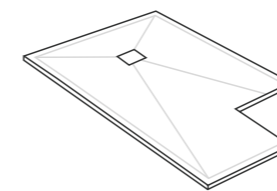

ADAPTABLE TO NON-STANDARD INSTALLATIONS

ADAPTABLE TO COMPLEX SPACES SUCH AS CORNERS, COLUMNS AND INCLINED WALLS



SIZES

Length \ Width	36" (914 mm)	42" (1067 mm)	48" (1219 mm)	60" (1524 mm)	72" (1829 mm)	80" (2032 mm)
30" (762 mm)						
32" (813 mm)						
36" (914 mm)						

Please contact us for further information over sizes
The manufacturer accepts 5 mm (0.2") variance

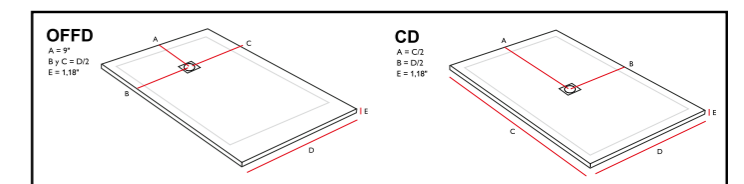

Shower bases made from a mix of resin, mineral fillers and gel coat.

The Stone SIDE model adds originality to the range Stone thanks to the centered slope and to its rectangular design grid.

STONE COLLECTION
NOI TCELLLOS ENOTS
EDIS









INFORMATION

COLORS

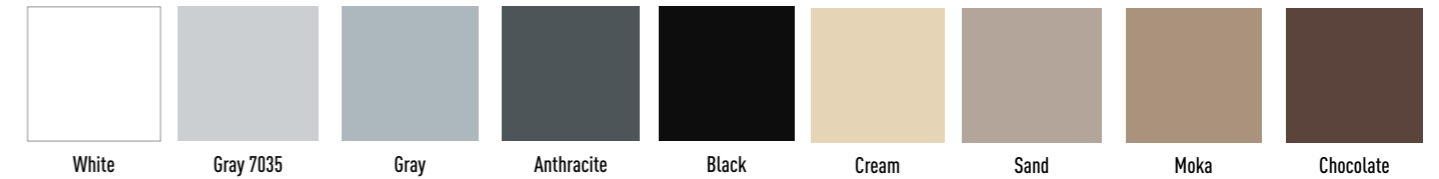

Manufacturing comes with a colored mass as from our color chart. Shower bases produced in any different color within the RAL chart entail a subsequent price increase. Products made with colors other than our color chart ones can not be returned.

TEXTURES



GRIDS INCLUDED IN PRICE



Stainless steel or painted to match color of the base (brushed stainless steel finish optional)

SHOWER DRAIN



Waste 60. Included in price

CUSTOMIZABLE

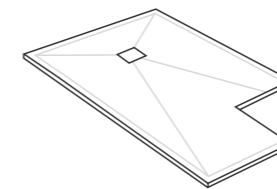

ADAPTABLE TO
NON-STANDARD
INSTALLATIONS

ADAPTABLE TO COMPLEX
SPACES SUCH AS CORNERS,
COLUMNS AND INCLINED
WALLS

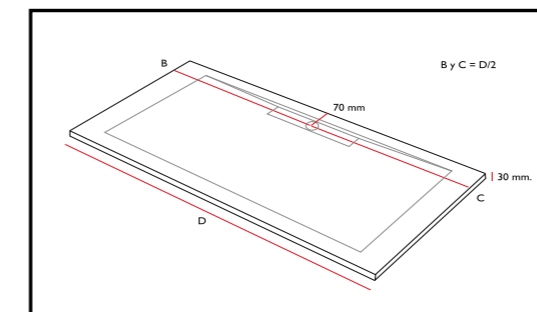

Shower bases made from a mix of resin, mineral fillers and gel coat.

The Stone MIO model, another addition to the Stone range. New lines and a corner grid making this model unique and exclusive



STONE COLLECTION
MIO











INFORMATION

COLORS

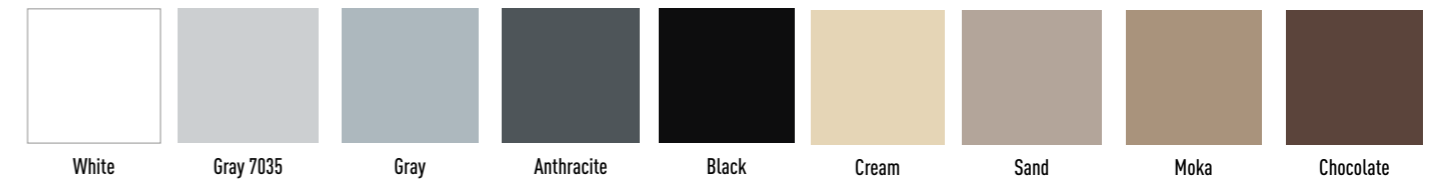

Manufacturing comes with a colored mass as from our color chart. Shower bases produced in any different color within the RAL chart entail a subsequent price increase. Products made with colors other than our color chart ones can not be returned.

TEXTURES



SMOOTH

GRIDS INCLUDED IN PRICE



STAINLESS STEEL GRID

COLOR GRID

Stainless steel or painted to match color of the base (brushed stainless steel finish optional)

SHOWER DRAIN



Waste 90. Included in price

CUSTOMIZABLE

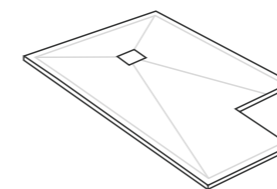

ADAPTABLE TO
NON-STANDARD
INSTALLATIONS

ADAPTABLE TO COMPLEX
SPACES SUCH AS CORNERS,
COLUMNS AND INCLINED
WALLS

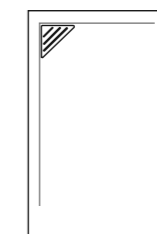
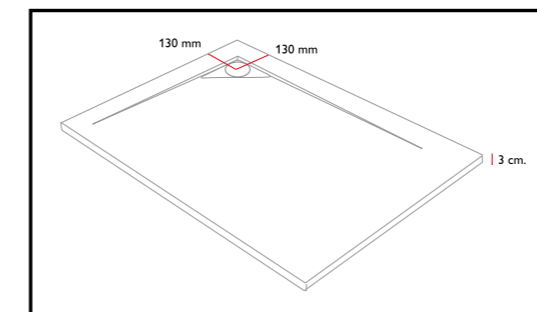

Left

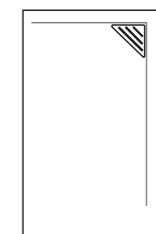

Right

The Mio model can be manufactured in both Senses, right and left.

Shower bases made from a mix of resin, mineral fillers and gel coat.

STONE COLLECTION
CACH

The Stone CACH model, a frame with soft gradient and a rectangular grid give this model its own character.











INFORMATION

COLORS

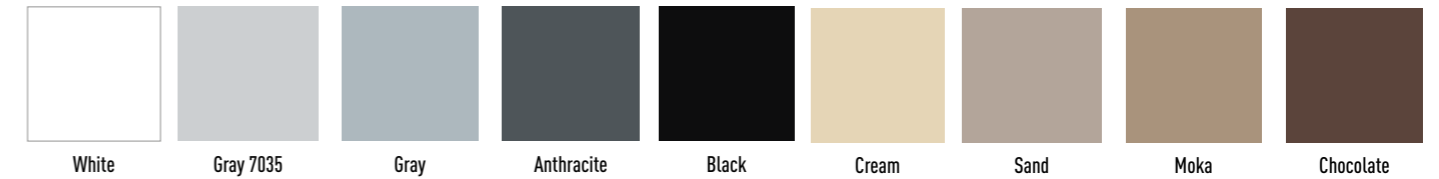

Manufacturing comes with a colored mass as from our color chart. Shower bases produced in any different color within the RAL chart entail a subsequent price increase. Products made with colors other than our color chart ones can not be returned.

TEXTURES



SMOOTH

SLATE

GRIDS INCLUDED IN PRICE



STAINLESS STEEL GRID

COLOR GRID

Stainless steel or painted to match color of the base (brushed stainless steel finish optional)

SHOWER DRAIN



Waste 60. Included in price

CUSTOMIZABLE

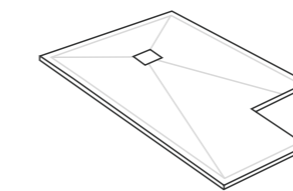

ADAPTABLE TO NON-STANDARD INSTALLATIONS

ADAPTABLE TO COMPLEX SPACES SUCH AS CORNERS, COLUMNS AND INCLINED WALLS

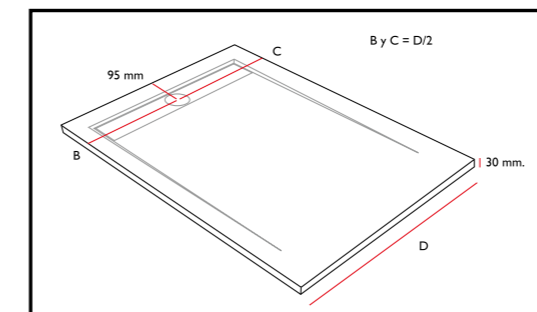

Shower bases made from a mix of resin, mineral fillers and gel coat.

In the Stone SMART model, the rectangular grille camouflaged together with the degraded frame of the tray, elevate the design to its maximum power.

STONE COLLECTION SMART

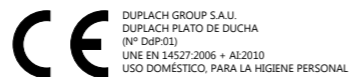



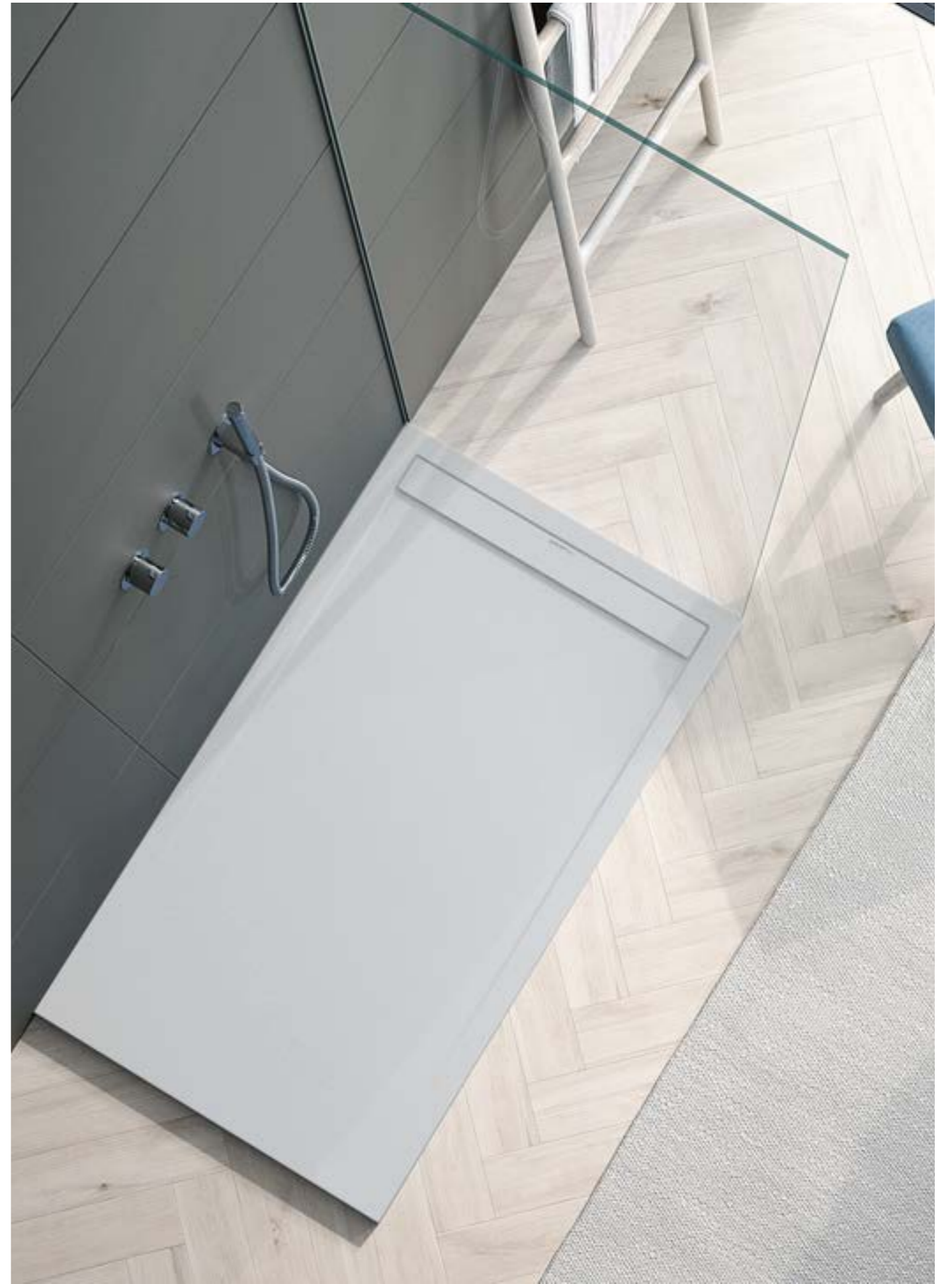





INFORMATION

COLORS

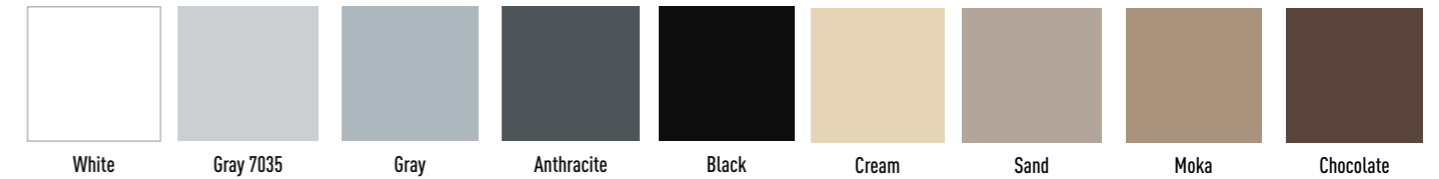

Manufacturing comes with a colored mass as from our color chart. Shower bases produced in any different color within the RAL chart entail a subsequent price increase. Products made with colors other than our color chart ones can not be returned.

TEXTURES



SMOOTH

SLATE

GRIDS INCLUDED IN PRICE



COLOR GRID

Stainless steel painted to match color of the base (brushed stainless steel finish optional)

SHOWER DRAIN



Waste 60. Included in price

CUSTOMIZABLE

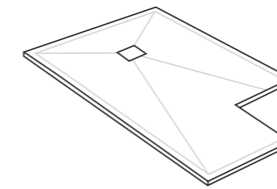

ADAPTABLE TO
NON-STANDARD
INSTALLATIONS

ADAPTABLE TO COMPLEX
SPACES SUCH AS CORNERS,
COLUMNS AND INCLINED
WALLS

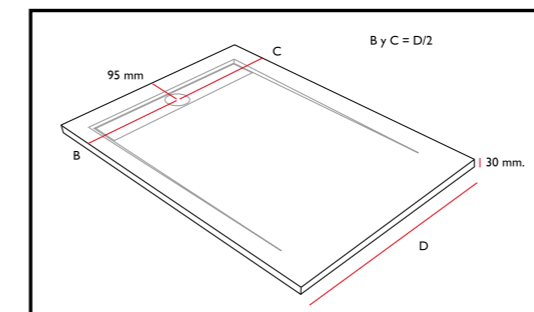

Shower bases made from a mix of resin, mineral fillers and gel coat.

In the Stone SORTY model, the centered grid and a smoother design give this tray a unique aesthetic and functionality.



STONE COLLECTION SORTY



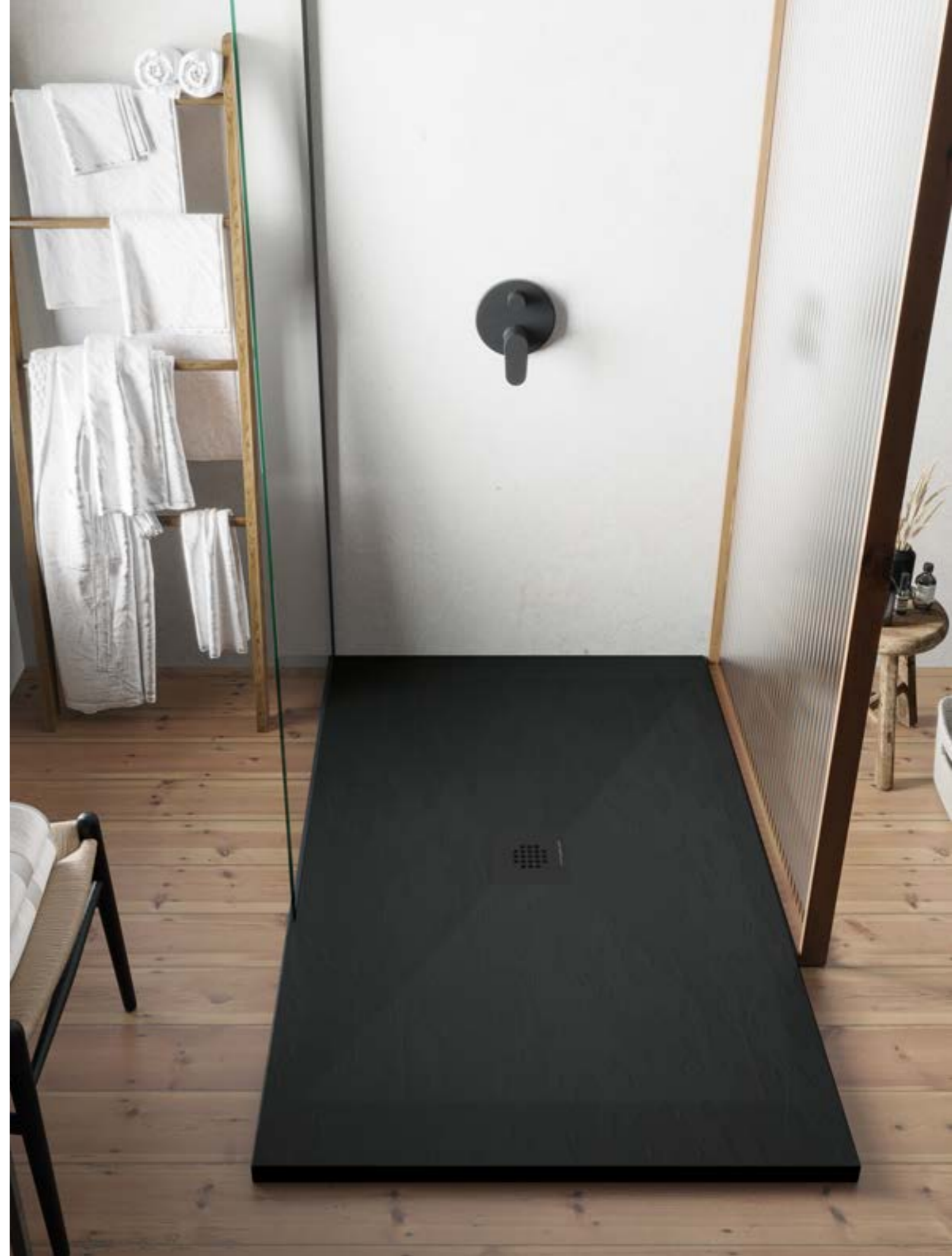







INFORMATION

COLORS

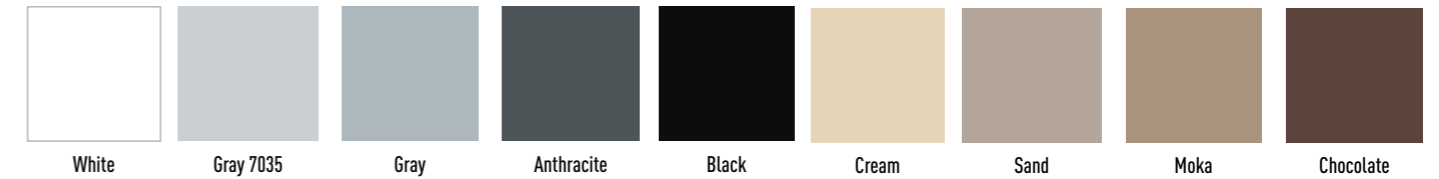

Manufacturing comes with a colored mass as from our color chart. Shower bases produced in any different color within the RAL chart entail a subsequent price increase. Products made with colors other than our color chart ones can not be returned.

TEXTURES



SLATE

GRIDS INCLUDED IN PRICE



STAINLESS STEEL GRID

COLOR GRID

Stainless steel or painted to match color of the base (brushed stainless steel finish optional)

SHOWER DRAIN



For 2" connection, meeting with the cUPC standards. Included in price

CUSTOMIZABLE

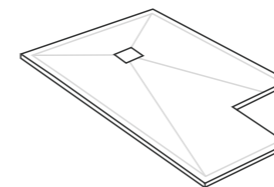

ADAPTABLE TO NON-STANDARD INSTALLATIONS

ADAPTABLE TO COMPLEX SPACES SUCH AS CORNERS, COLUMNS AND INCLINED WALLS



SIZES

Length	36"	42"	48"	60"	72"	80"
Width	(914 mm)	(1067 mm)	(1219 mm)	(1524 mm)	(1829 mm)	(2032 mm)
32" (813 mm)						
36" (914 mm)						

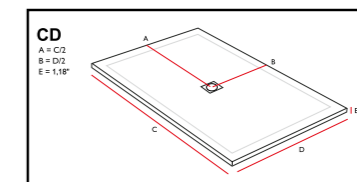

Please contact us for further information over sizes
The manufacturer accepts 5 mm (0.2") variance

Shower bases made from a mix of resin, mineral fillers and gel coat.

Stone 3D presents the most creative line, allowing the simulation of noble materials, industrial finishes, abstract designs... creating a unique bathroom.

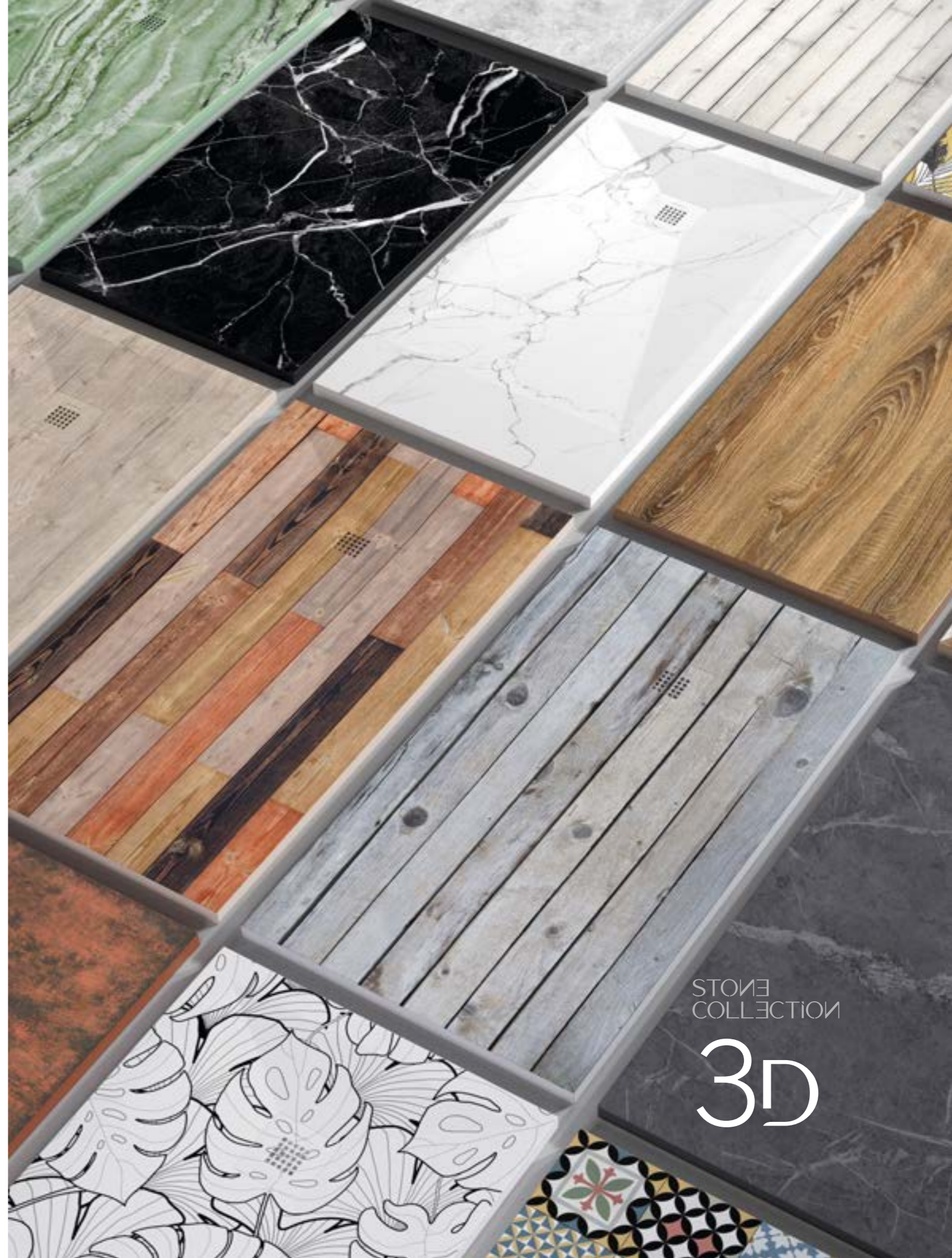

STONE COLLECTION
ENJOY

3D



AT *DUPLACH* WE HELP YOU
CREATE YOUR ENVIRONMENT



I. Cement



Concrete



Cement 01



Cement 02



Cement 03



Cement 04



Cement 05



Cement 06



Cement 07



Cement 08



UNCARVED **MARBLE** CAN CONTAIN THE
BEST WORKS IN AN ARTIST'S THOUGHT.





Black Marble

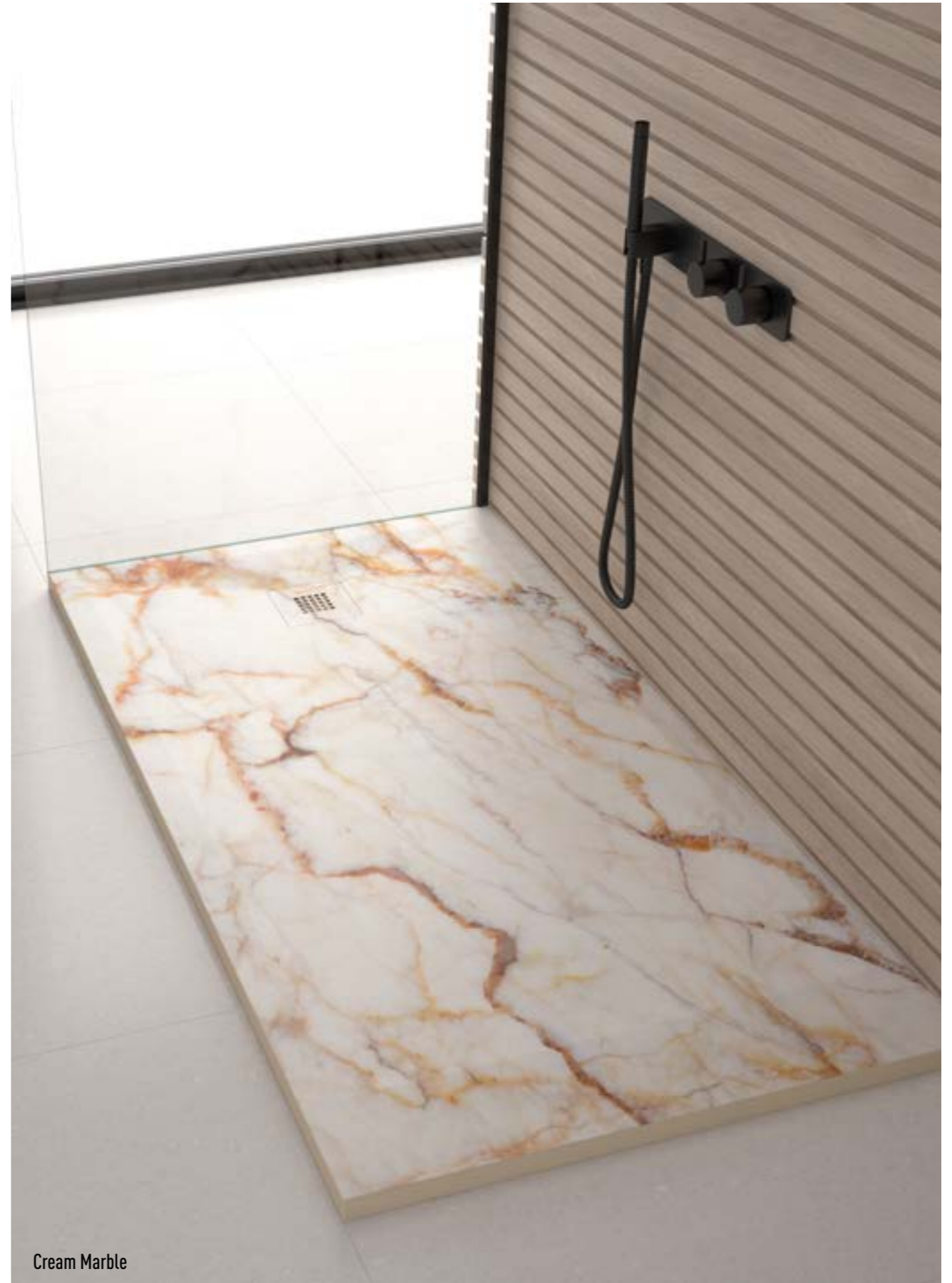

Cream Marble



White Granite



Black Terrazzo



Gray Terrazzo



Beige Terrazzo



01 BW Mosaic



01 Colour Mosaic





Colour Hydraulic



BW Hydraulic



Marquina



Light Brown Oasis



Brown Travertine



Green Travertine



Oxide Marble

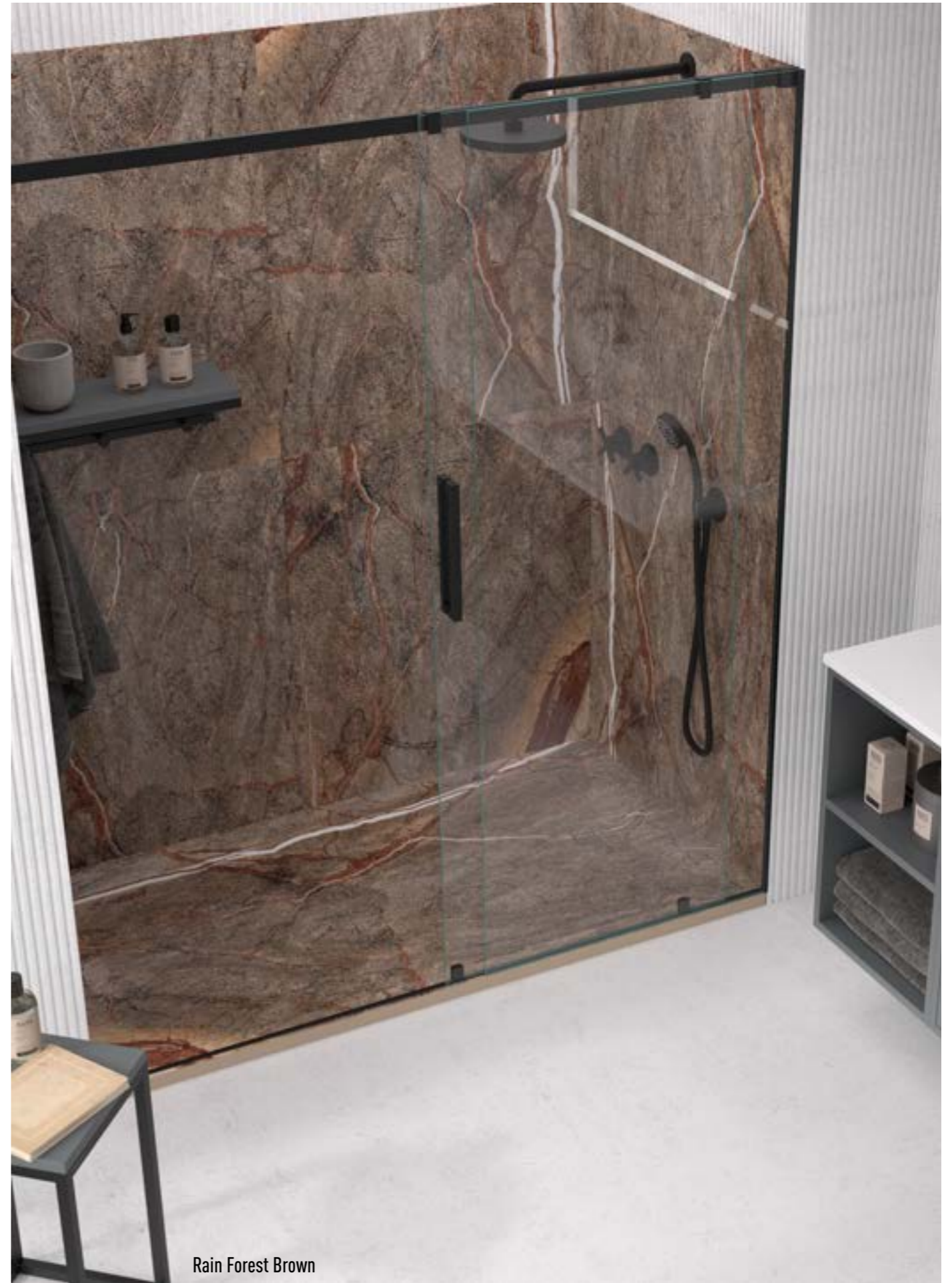

Rain Forest Brown





Dark Brown Oasis



Emperor Brown



WOOD IS A UNIVERSALLY BEAUTIFUL NOBLE MATERIAL FOR THE PEOPLE.



Walnut



Oak



Vintage



Ash



Decapé



Nature



Baobab



Olive 01



Olive 02



Ebony



White Patina



Vintage White



Grey Rustic



Natural Rustic



Blue Rustic



White Pine



White



Rustic



Mocha Oak



Flanders Pine



Natural Pine



Smoked Oak

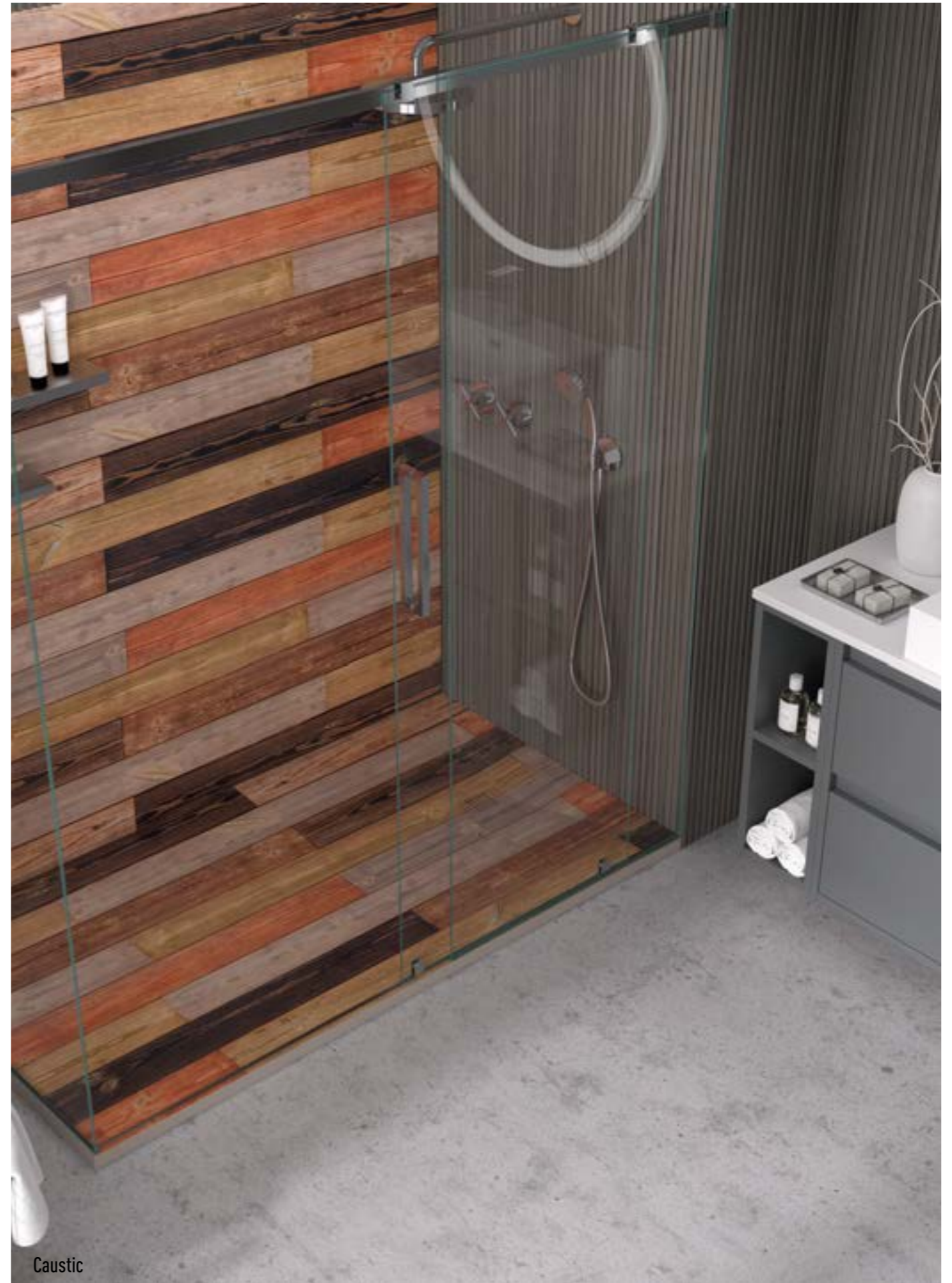



LOOK AT NATURE AND THEN YOU WILL
UNDERSTAND EVERYTHING BETTER



Leaves 01

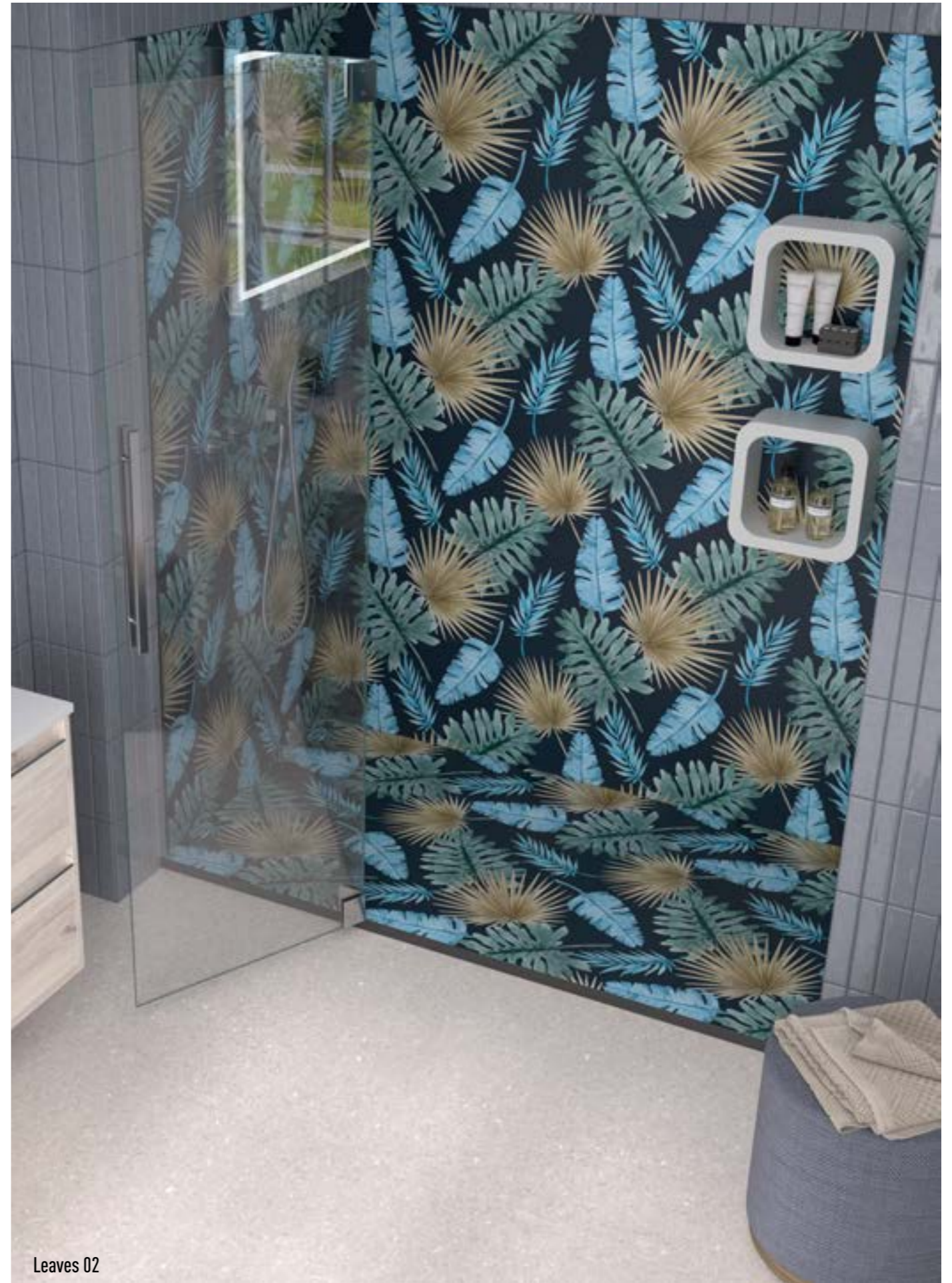

Leaves 02





Grass



Oxide



IN A DROP OF **WATER** THE SECRETS OF
ALL THE SEAS ARE FOUND



Drops



Pool water



Sea



Calm

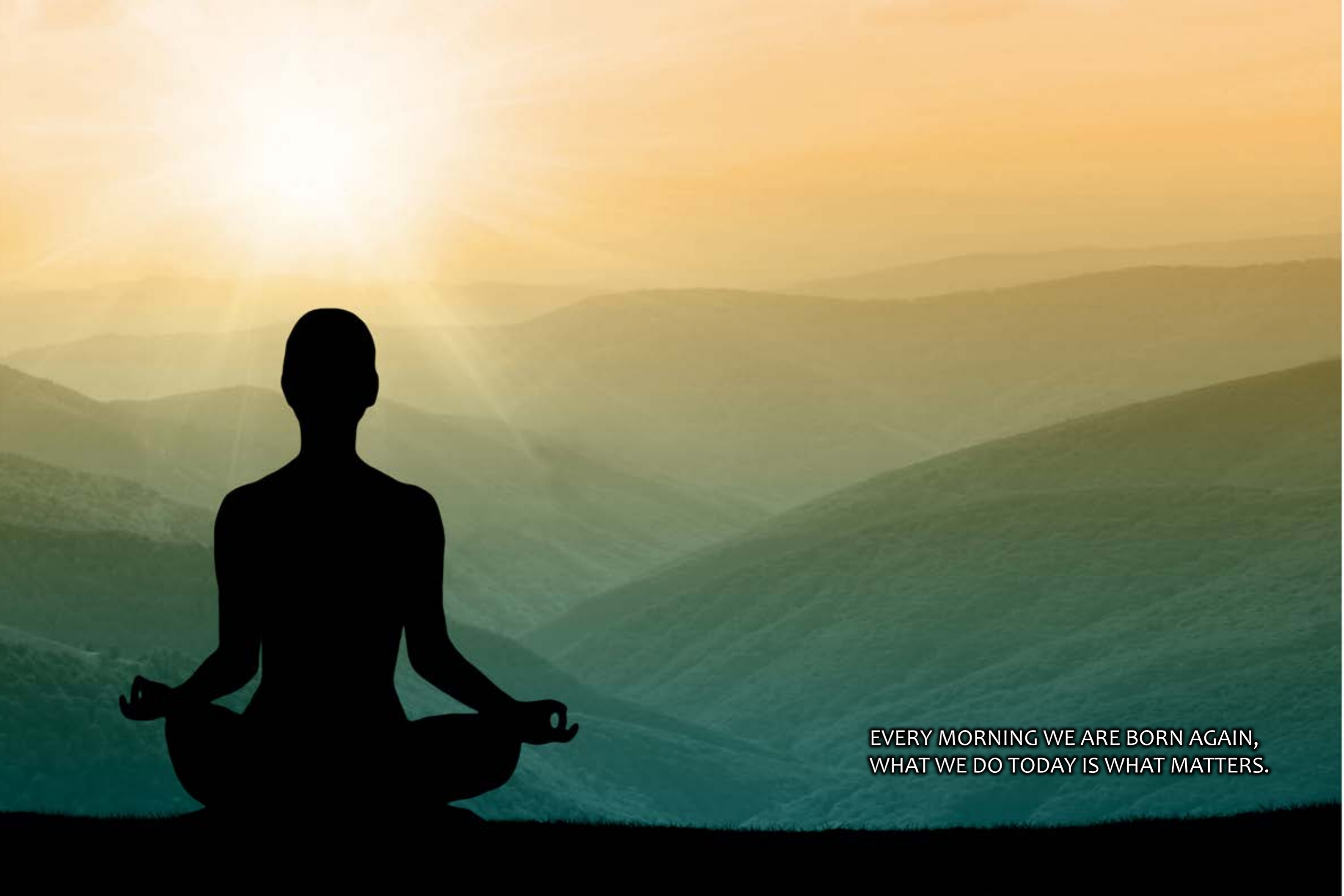

EVERY MORNING WE ARE BORN AGAIN,
WHAT WE DO TODAY IS WHAT MATTERS.



Zen 01



Zen 02



Zen 03



Zen 04



THAT GROWING UP DOES NOT
MEAN STOP BEING **CHILDREN**



Dots



Watercolour

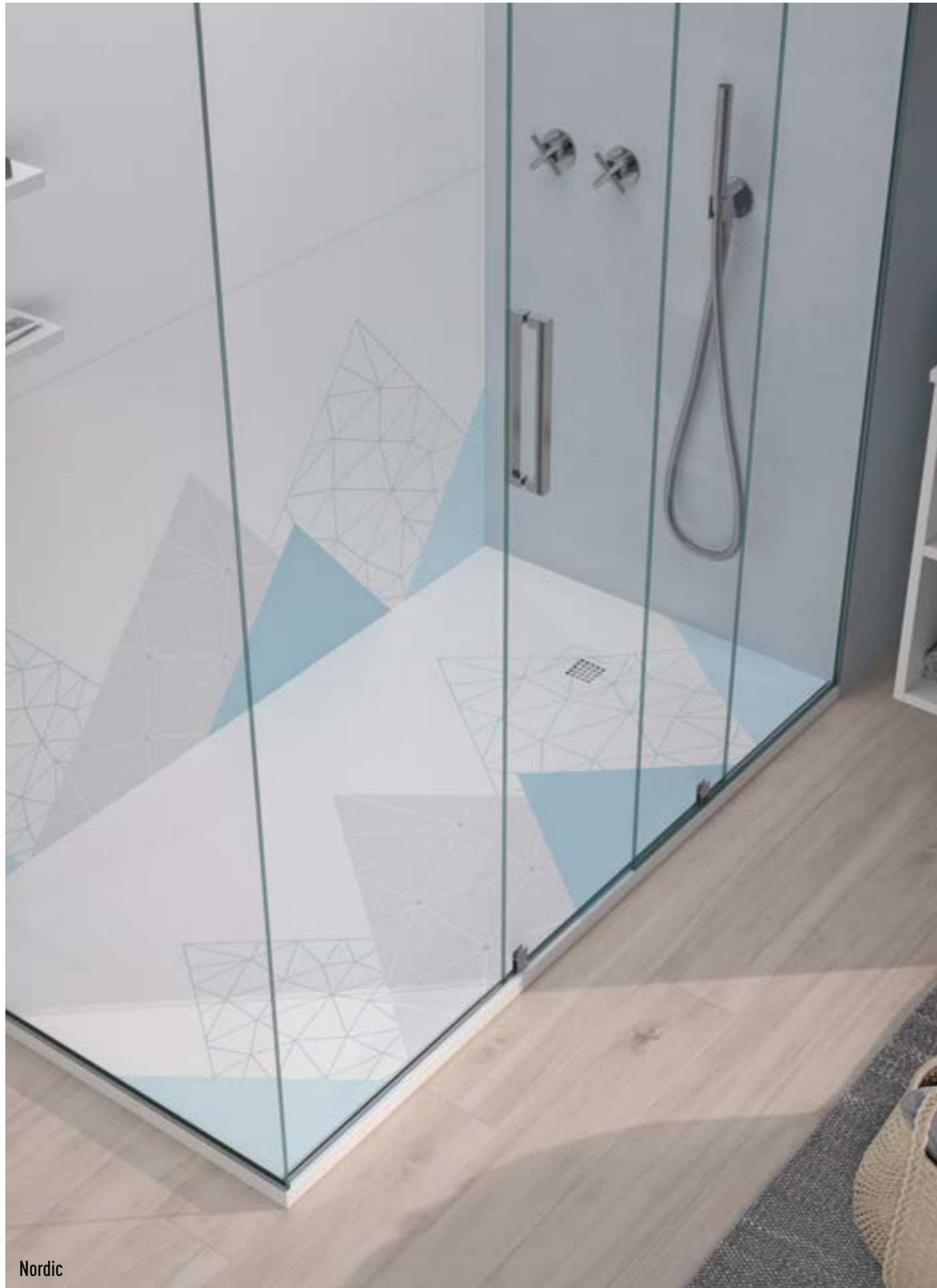

Nordic



Circle



Geometric 01



Geometric 03

INFORMATION

3D DESIGNS
Matching wall panels also available.

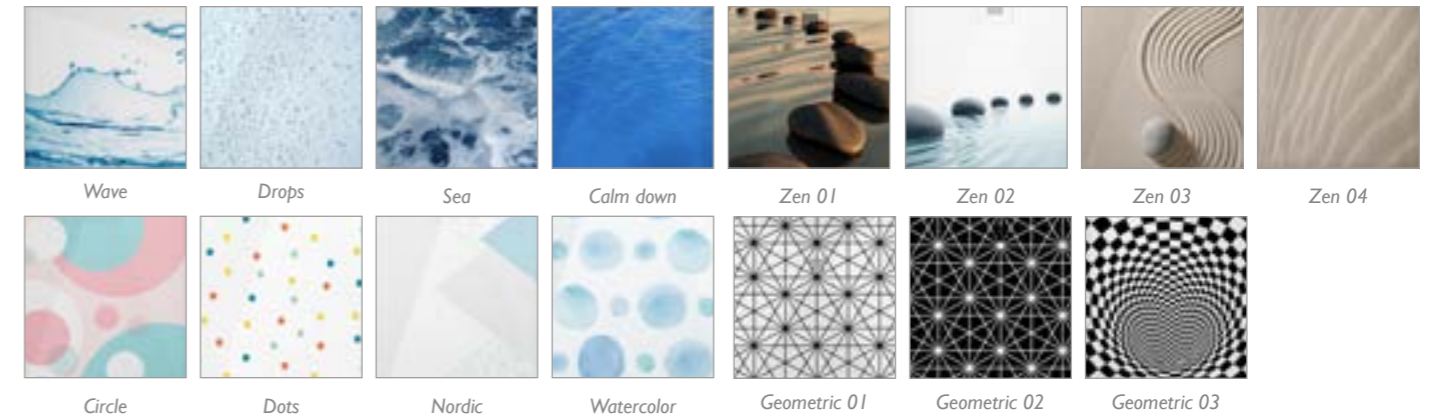
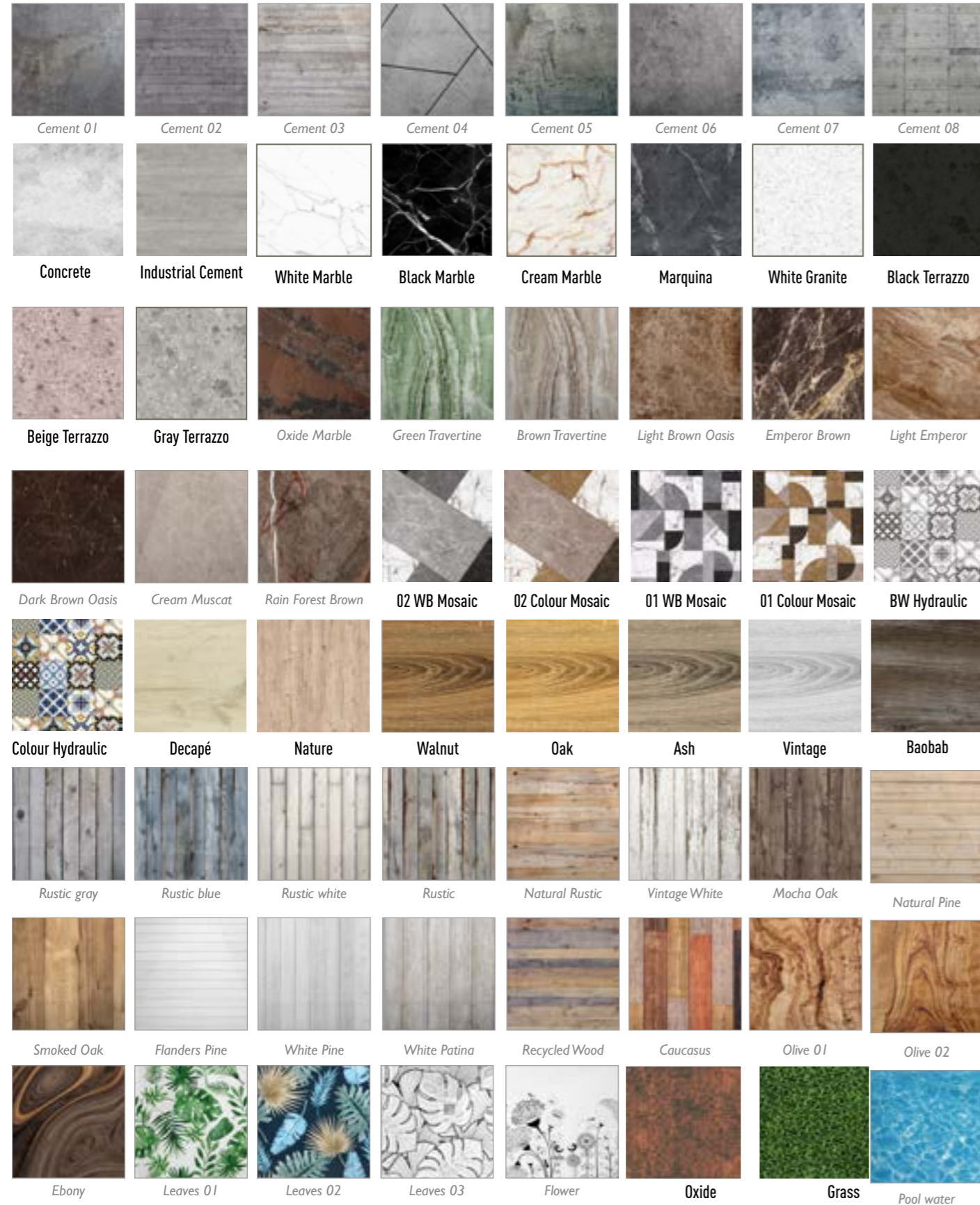

Il est fait sur une base de masse colorée dans les nuances de notre nuancier qui convient le mieux au design, auquel il est appliqué sur la face supérieure avec son propre système de numérisation, un design qui offre des possibilités infinies de personnalisation et de durabilité Garanti grâce à son revêtement avec GEL COAT.

Les produits fabriqués avec des conceptions autres que les normes indiquées ici sont exemptés de retour.

TEXTURES



SLATE

GRIDS INCLUDED IN PRICE



1 Sided Printed Grid
Included in price

SHOWER DRAIN



For 2" connection, meeting
with the CUPC standards.
Included in price

CUSTOMIZABLE

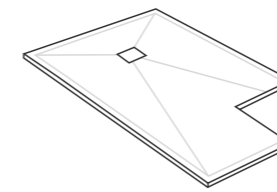

ADAPTABLE TO
NON-STANDARD
INSTALLATIONS

ADAPTABLE TO COMPLEX
SPACES SUCH AS CORNERS,
COLUMNS AND INCLINED
WALLS



SIZES

Length	36"	42"	48"	60"	72"	80"
	(914 mm)	(1067 mm)	(1219 mm)	(1524 mm)	(1829 mm)	(2032 mm)
Width						
32" (813 mm)						
36" (914 mm)						

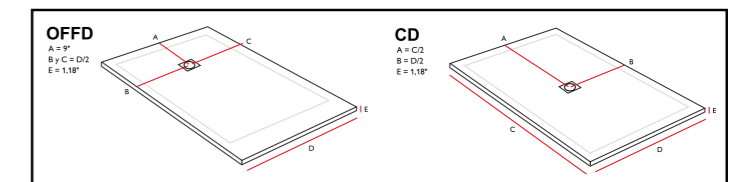

Please contact us for further information over sizes
The manufacturer accepts 5 mm (0.2") variance

Shower bases made from a mix of resin, mineral fillers and gel coat.

Wall panels with wonderful designs that give personality to your environment quickly and easily







Wall Panels

Installation Instructions













ATTENTION

**READ AND FOLLOW EACH STEP CAREFULLY.
2 PEOPLE REQUIRED. QUALIFIED INSTALLER REQUIRED**



ATTENTION

SUPPLIED ITEMS	REQUIRED TOOLS AND MATERIALS			
 Wall panels  Sketch	 Polyurethane glue	 Flexible/porcelain mortar	<p>OPTIONAL</p>  Circular saw	 Saw blade suitable for aluminium
	 Notched trowel  Sponge trowel	 Electrical drill	 Adhesive tape	<p>2 People Required</p> 



1

Check the route to the installation site. Check that the panels are in good condition. The panels can be installed vertically or horizontally.

2

Transport the panels between two people, perpendicular to the floor. Avoid resting the piece on the floor by its ends. Prepare a cutting table if it is needed.

3

Check planimetry of the wall. Check for the absence of humidity, dust, grease or other residues. Consult the attached sketch for the correct installation of the panels. Remove the protective film from the non-decorated side (if applicable). Drill the panel for faucets if necessary.



4

Apply porcelain/flexible mortar to the wall with a notched trowel. Apply the polyurethane glue to the wall panel in perimeter bead (3 cm from the edge) and vertically every 10 cm.

5

Place the wall panel and adjust to its final position. Adjustment time 15-20 min.

6

Repeat the same process with the second and successive panels. Leave a separation of 3mm between panels.



7

After placing all the wall panels, place adhesive tape on the joints to protect the panel during grouting. Apply polyurethane glue and remove the excess with sponge trowel. Remove the adhesive tape.

If on-site cutting is required:

Use a circular saw and saw blade suitable for aluminum. **Always cut on the decorated side.** Before cutting, fix the guide for a correct and straight cut.



WARNING: The installer must verify the correct evacuation and watertightness. NOT SUITABLE for outdoor installation.





WALL PANELS

MATERIAL

Aluminium composite PE 4 mm (0.2 mm)

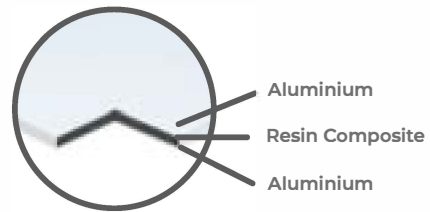

TEXTURES

Smooth

COLORS



Further finishes available.

DIMENSIONS

Panel Thickness: 4mm. (+ 0.2 mm)
Aluminum tickness: Avg. > 0.5 mm
Min. > 0.5 mm

Width: Max. 47"
Height: Max. 94"
Weight: 5.73 kg/m²

INCLUDED

Wall Panel
Installation Instructions

PROPERTIES

Tensile Strength: ≥ 100 MPa
Elongation: $\leq 2T$
Elasticity Module: $\geq 2.0 \times 10^4$ MPa
Thermal Expansion: $2.14 \times 10^{-5} \text{ } ^\circ\text{C}^{-1}$
Coating type: PE/PVDF
Coating adhesion: Class 0; Class 1 (ISO 2409)
Pencil Hardness: $\geq \text{HB}$ (ECCA T4)
Reaction to fire: B-S1-DO-TO

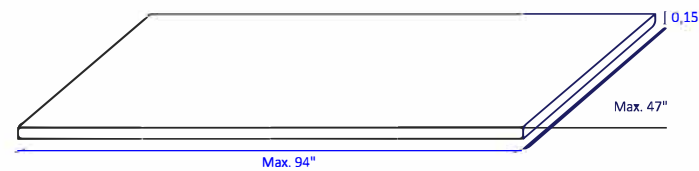

Aproximate measurements. The manufactures accepts 0,02mm variance.
Wall panels can be cut on site with a serrated disc for aluminium.

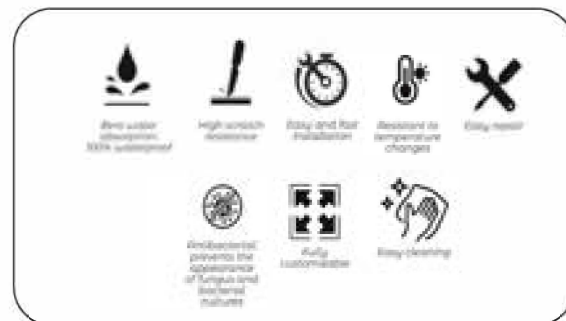

KIT WALL PANELS

MATERIAL

Aluminium composite PE 4 mm (0.2 mm)

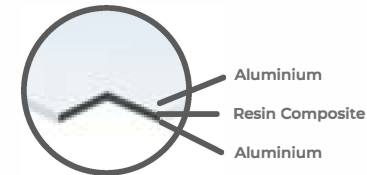

TEXTURES

Smooth

COLORS



Further finishes available.

DIMENSIONS

Panel Thickness: 4mm. (+ 0.2 mm)
Aluminum tickness: Avg. > 0.5 mm
Min. > 0.5 mm

Width: 30", 32" or 36"
Height: 90"
Weight: 5.73 kg/m²

INCLUDED

Wall Panel
Sketch
Installation Instructions

OPTIONS

Single Threshold (Kit U)
Double Threshold (Kit L)

PROPERTIES

Tensile Strength: ≥ 100 MPa
Elongation: $\leq 2T$
Elasticity Module: $\geq 2.0 \times 10^4$ MPa
Thermal Expansion: $2.14 \times 10^{-5} \text{ } ^\circ\text{C}^{-1}$
Coating type: PE/PVDF
Coating adhesion: Class 0; Class 1 (ISO 2409)
Pencil Hardness: $\geq \text{HB}$ (ECCA T4)
Reaction to fire: B-S1-DO-TO



KIT L Double Threshold

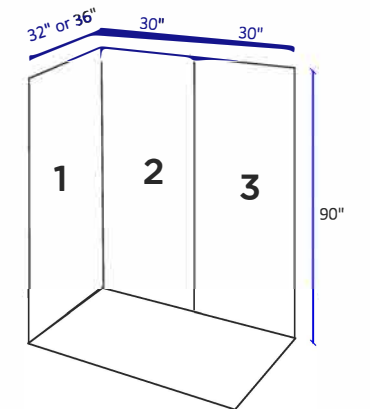

KIT U Single Threshold

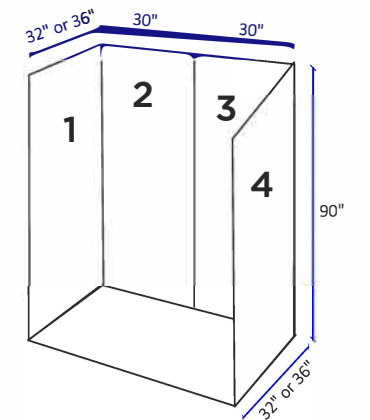

Aproximate measurements. The manufacturer accepts 0,02mm variance.
Wall panels can be cut on site with a serrated disc for aluminium.

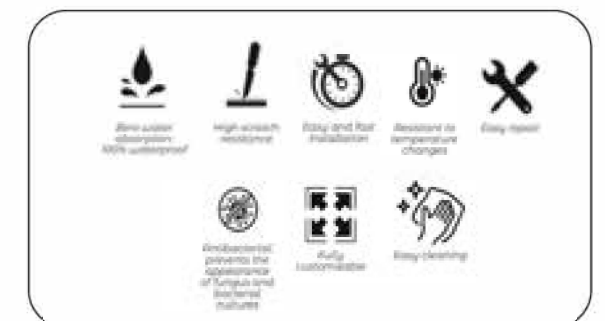

The OHU Collection offers a line of essential accessories to complete your bathroom.





INSTRUCTIONS FOR CUTTING

⚠ ATTENTION: Read and follow entirely all the steps

CUTTING AREA // HOW TO CUT

Shower bases can be cut on site along its length with a diamond blade as long as the cutting area does not invade the internal rectangle (in yellow) which guarantee the slopes and consequently the drainage system will not be affected. The shower base must be cut preferably on the bottom area.

Be aware of make room for tile flange installation on all sides where it will be installed.

** Notice it will be necessary to apply filler and painting on the cut edge if it is visible.

** If a bigger or different cut is required, please, contact us for further instructions.

** Cuttings along its width cannot be made on site. Please, contact us for further instructions.

⚠ MAKE SURE SIDE BEING CUT BE THE ONE RECESSED AGAINST THE WALL

60x32 OFFD

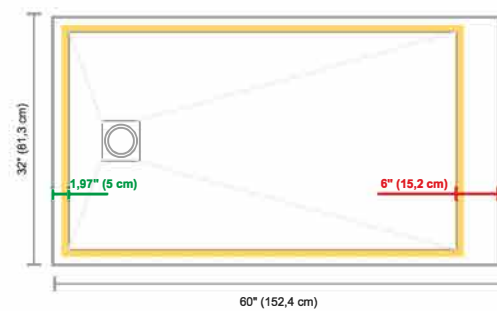

Following these instructions, there is a tolerance suitable for cutting of 6" on the bottom area (red) and 1.97" on the upper area (green).

60x36 OFFD

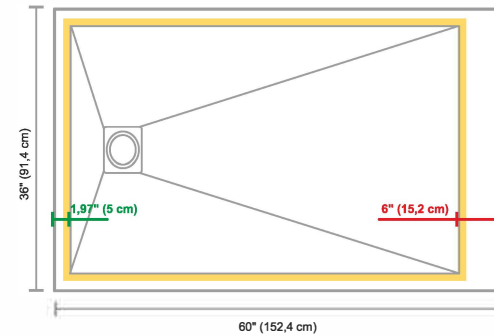

Following these instructions, there is a tolerance suitable for cutting of 5.98" on the bottom area (red) and 1.97" on the upper area (green).

48x32 OFFD

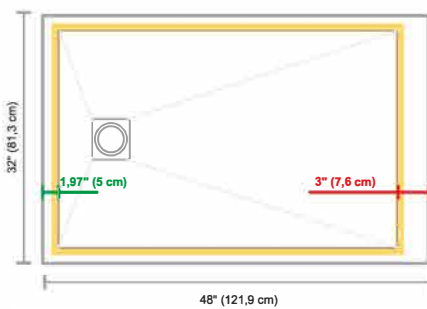

Following these instructions, there is a tolerance suitable for cutting of 3" (red) on the bottom area and 1.97" (green) on the upper area.

36x36 CD

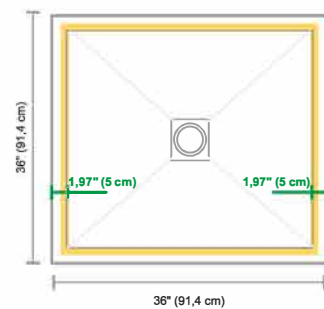

Following these instructions, there is a tolerance suitable for cutting of 1.97" (green) on each side.

48x36 CD

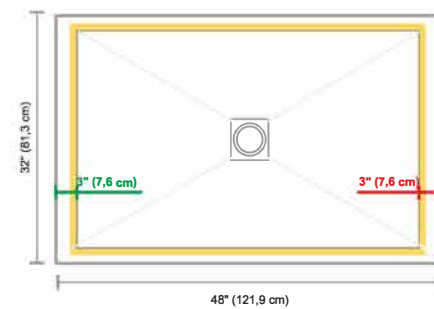

Following these instructions, there is a tolerance suitable for cutting of 3" (red) on the bottom area and 3" (green) on the upper area.

⚠ Attention: It is the installer's responsibility to ensure a proper sealing and drainage of the shower base. Cuttings and any other modifications made to the product are not covered by the warranty.

INSTRUCTIONS FOR CUTTING

⚠ ATTENTION: Read and follow entirely all the steps

TOOLS AND MATERIALS REQUIRED

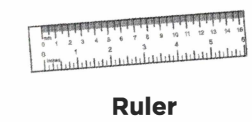
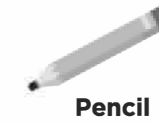

1 Prepare the work area by installing wooden slats over chocks to prevent the cutting tool from damaging the floor.

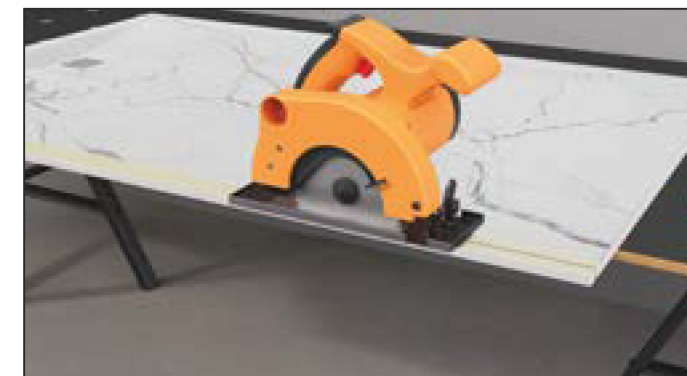

2 Measure and mark the cut area. Draw the line using a ruler on the top side of the shower base.



3 Use masking tape to protect the cutting area where the circular saw passes to avoid scratching.

4 Cut the area using an appropriate tool and make sure the cut is clean and continuous.

⚠ Attention: It is the installer's responsibility to ensure a proper sealing and drainage of the shower base. Cuttings and any other modifications made to the product are not covered by the warranty.

DO NOT INSTALL THIS FIXTURE AGAINST A WALL UNLESS THE APPROPRIATE FLANGE IS FIRST INSTALLED



ATTENTION

THIS PRODUCT MUST BE INSTALLED BY A QUALIFIED PLUMBER. MAINTAIN THE SURFACE OF THE BASE PROTECTED AT ALL TIMES DURING THE INSTALLATION. THIS PACKAGING BOX CONTAINS FOAM FILM YOU CAN USE TO PROTECT THE BASE DURING THE INSTALLATION ALONG WITH THE BOX LID. PLACE THE FOAM FILM ON THE SURFACE OF THE BASE AND THEN THE BOX LID ON THE FOAM FILM BEFORE INSTALLING, ENSURE TO REMOVE ANY STAPLE FROM THE BOX LID BEFORE USE. ALSO, WATCH FOR SCREWS, STAPLES, DIRT, OR OTHER DEBRIS THAT CAN FALL ON TO THE BASE AND WILL POSSIBLY CAUSE SCRATCHES IF STEPPED ON.



2 People Required

Before you begin

MATERIALS AND TOOLS



IMPORTANT - STORE BASE ON FLAT

PRIOR TO INSTALLATION

READ ENTIRELY THE INSTRUCTIONS. FOLLOW LOCAL PLUMBING AND BUILDING CODES

Prior to installation, the shower base must be checked thoroughly for defects. In the unlikely event that the product has a defect, it must not be installed.

The manufacturer will not be held responsible for the costs of removal or replacement of a shower base or any other costs incurred as a result of the shower base having a defect if said defect was identifiable prior to installation.

INSTALLATION OF THE SHOWER BASE WILL BE TREATED AS ACCEPTANCE OF QUALITY.

Place the shower base on a flat level surface.



Using a spirit level, ensure that all outer edges of the shower base are flat and level as per figure 1.

If any of the levels cannot be corrected when embedding the shower base, then it may be twisted or distorted. If this is the case, then the shower base must not be installed and should be returned to the retailer for replacement.



Figure 1

INSTALLATION

This product must be installed by a qualified plumber. It is the installer's responsibility to ensure a proper installation, a trouble-free water evacuation and a total watertightness.

Note that this shower base is suitable for installation on both concrete and wooden floors (never on sand only). If fitting to a wooden floor, it is recommended that the ground be made from wood resisting delamination under humid conditions.

Recommended installation:

1.- Before installing the shower base:

1.1.- Install the tile flange to the base and seal the corners with polyurethane glue as per Figure 2.

1.2.- Then install the shower drain to the shower base. Drain can not arise from the surface otherwise it will not flow properly.



Figure 3a

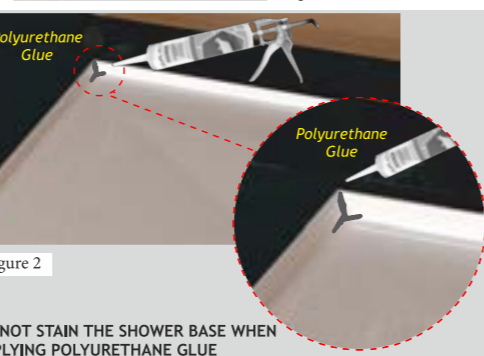

Figure 3b

Do not install this fixture against a wall unless the appropriate flange is first installed.

2.- For the perfect installation of the shower base, it is necessary to create a completely level surface, smooth and dry.

a) For concrete floors:

Pour flexible cement glue for porcelain stoneware tiles on the concrete floor. Spread evenly with a notched trowel as per figure 3a.

b) For wooden floors:

Use polyurethane glue on the wooden floor as



Figure 2

DO NOT STAIN THE SHOWER BASE WHEN APPLYING POLYURETHANE GLUE

be in contact with the floor area as per figure 4.

4.- Settle the shower base into final position and tap level as per figure 5.

5.- Allow the adhesive to set before applying any further weight to the shower base.

6.- Now that the shower base is in final position, place the drain cover on the base.

7.- Before proceeding any further, the shower base must be checked for proper drainage with good water volume poured on to all shower base areas.

If the shower base fails to drain water suitably, then double check that it is level. If the base is level and still fails to drain water, then there may be a blockage in the drainage pipe.

In the unlikely event that the base is faulty, the installation must be halted and the shower base returned to the supplier for replacement.

Tiles/panelling/shower doors/screens or any other fixtures relating to the shower area must not be fitted if the shower base has a fault.

The shower base may not properly drain with integral siphon drains if a second siphon is installed.

8.- It is the installer's responsibility to ensure a total watertightness.

For that purpose, it is recommended to seal the joints, reinforce the flange and the shower drain body with a suitable waterproof caulking without affecting the product features. Oil based caulking, plumber's putty and polyurethane glue are not recommended.

Do not use the shower base within the first 24 hours after installation.



CHECK THAT THE SHOWER BASE DRAINS PROPERLY.

IF IN DOUBT, CONTACT YOUR SUPPLIER

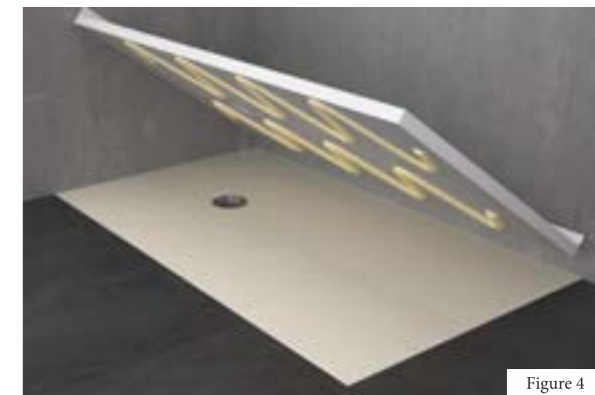

Figure 4



Figure 5



Do NOT drill, screw or perforate the shower base

FINAL RESULT

MAINTENANCE



Clean regularly with a PH Neutral detergent,



To remove any residue, simply wipe with



Avoid the use of scouring sponges

