



venture

MAXFINE

iris

120" X 60"

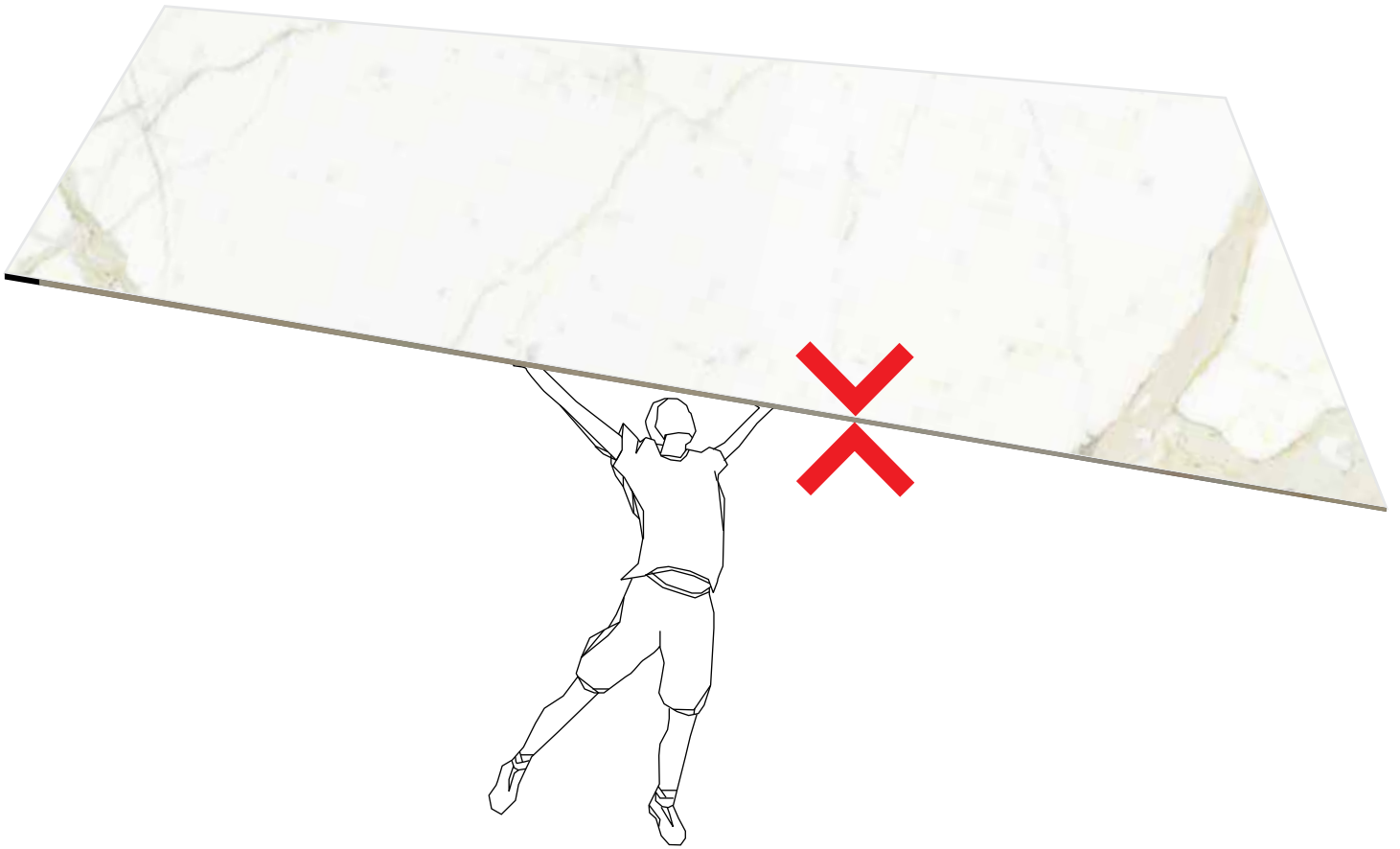

MAXFINE
irbs

/ Index

Size Range	/ 03
Applications	/ 05
Color Range	/ 34
Bookmatches	/ 38
Sizes Available	/ 42
Limitations & Responsibilities	/ 50
General Instructions	/ 51
Packaging	/ 68
Technical Specifications	/ 69

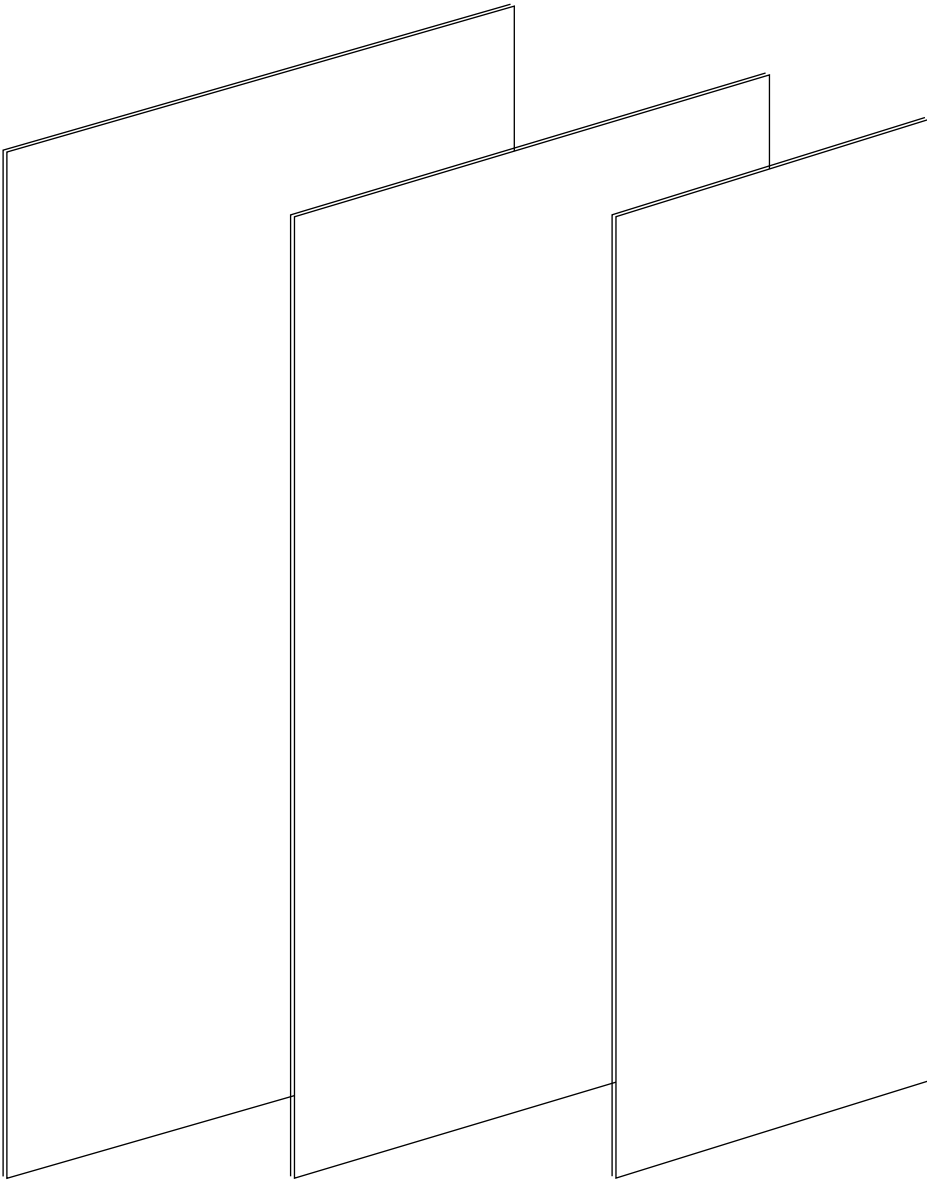

128" x 64" *

120" x 60"

128" x 40"

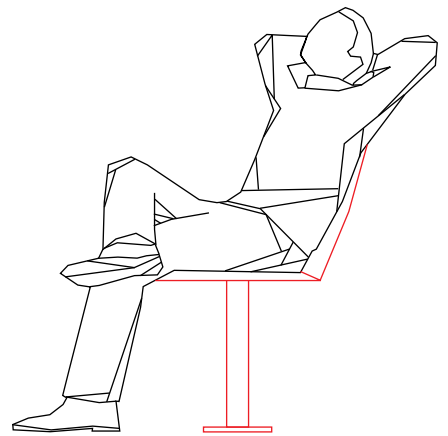

*Available upon request.

THE SIZE
AND SHAPE
YOU NEED

✂ 6 MM

✂ 10 MM*

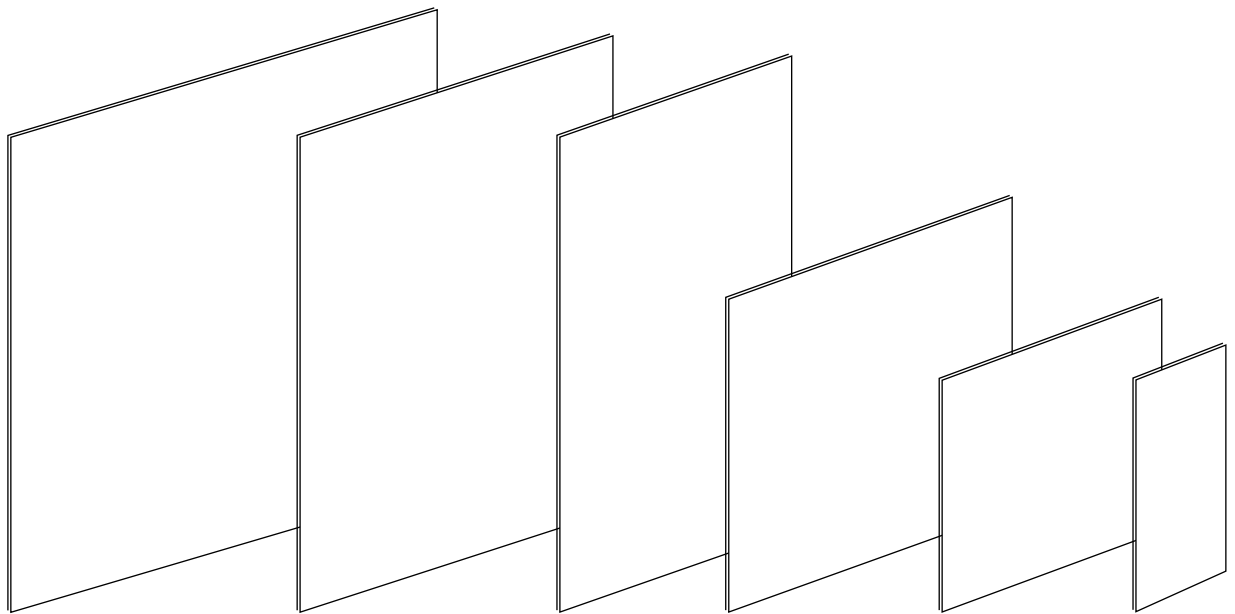

60" x 60"

60" x 40"

60" x 30"

40" x 40"

30" x 30"

30" x 15"

*Available upon request.

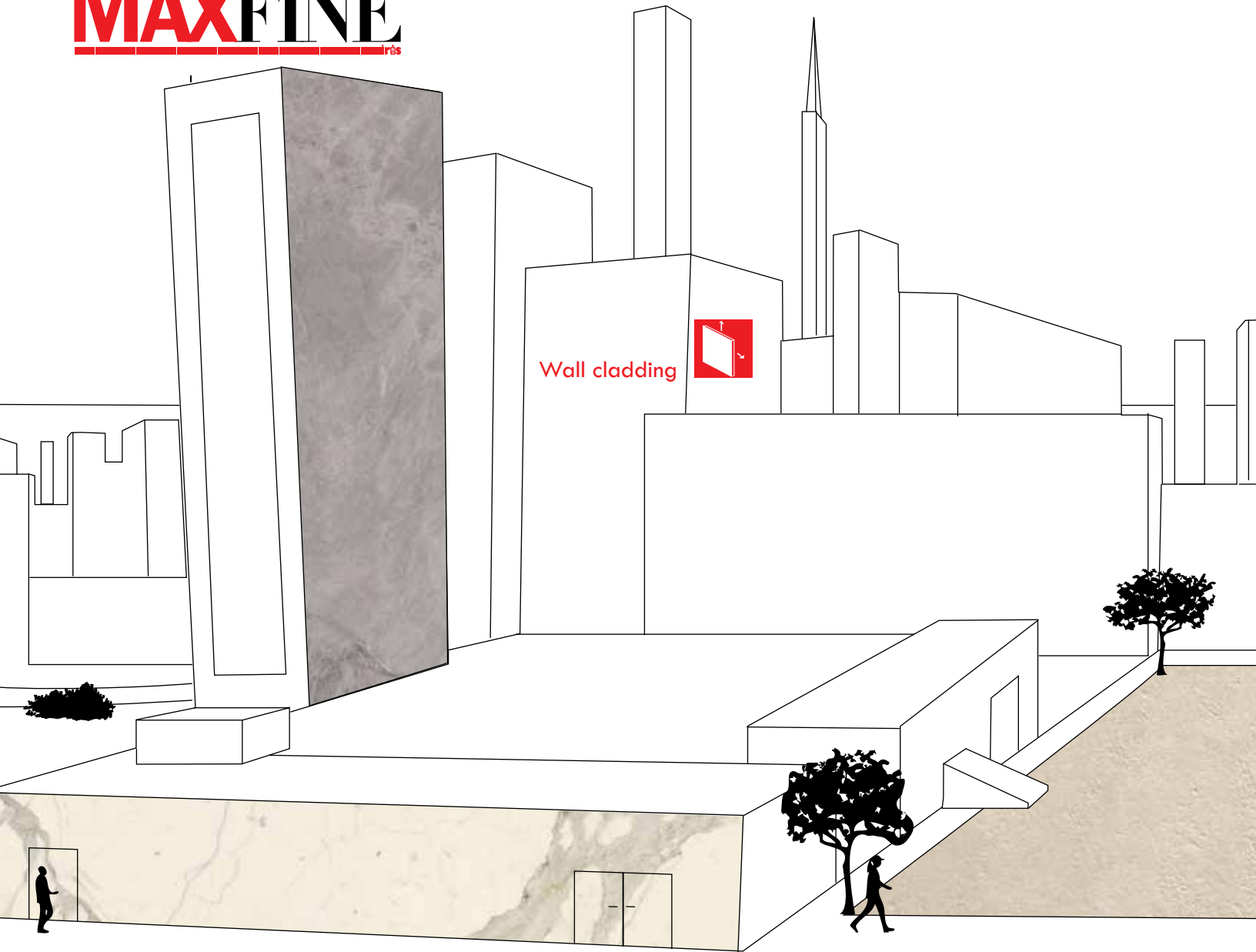

Wall cladding



Doors



Inside / Outside

Slabs so innovative and versatile that they break down the barriers between surfaces for architecture and furnishing, between indoor and outdoor use. The freedom to design grows, with solutions that were impossible until yesterday.

/ Applications



Floor / Wall



Boat interior design



Hotel / Wellness



Counter top



Indoor / Outdoor furniture

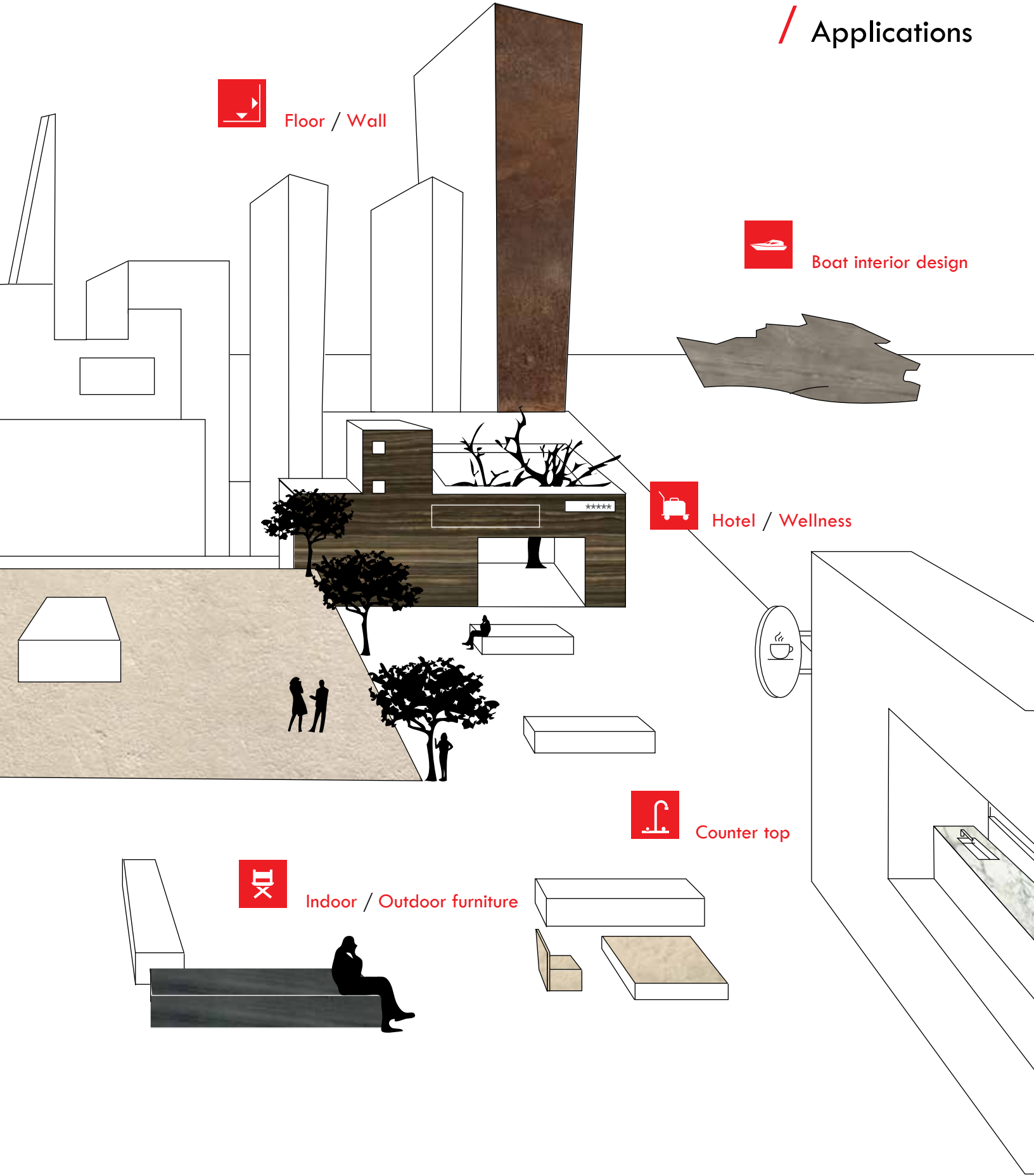



Wall_Marmi Calacatta
Floor_Marmi Calacatta
Counter top_Marmi Calacatta
Furniture_Roads Dark Depth







Wall_Marmi Calacatta
Elevator Floor_Marmi Calacatta



Wall_Marmi Bianco Venato Extra

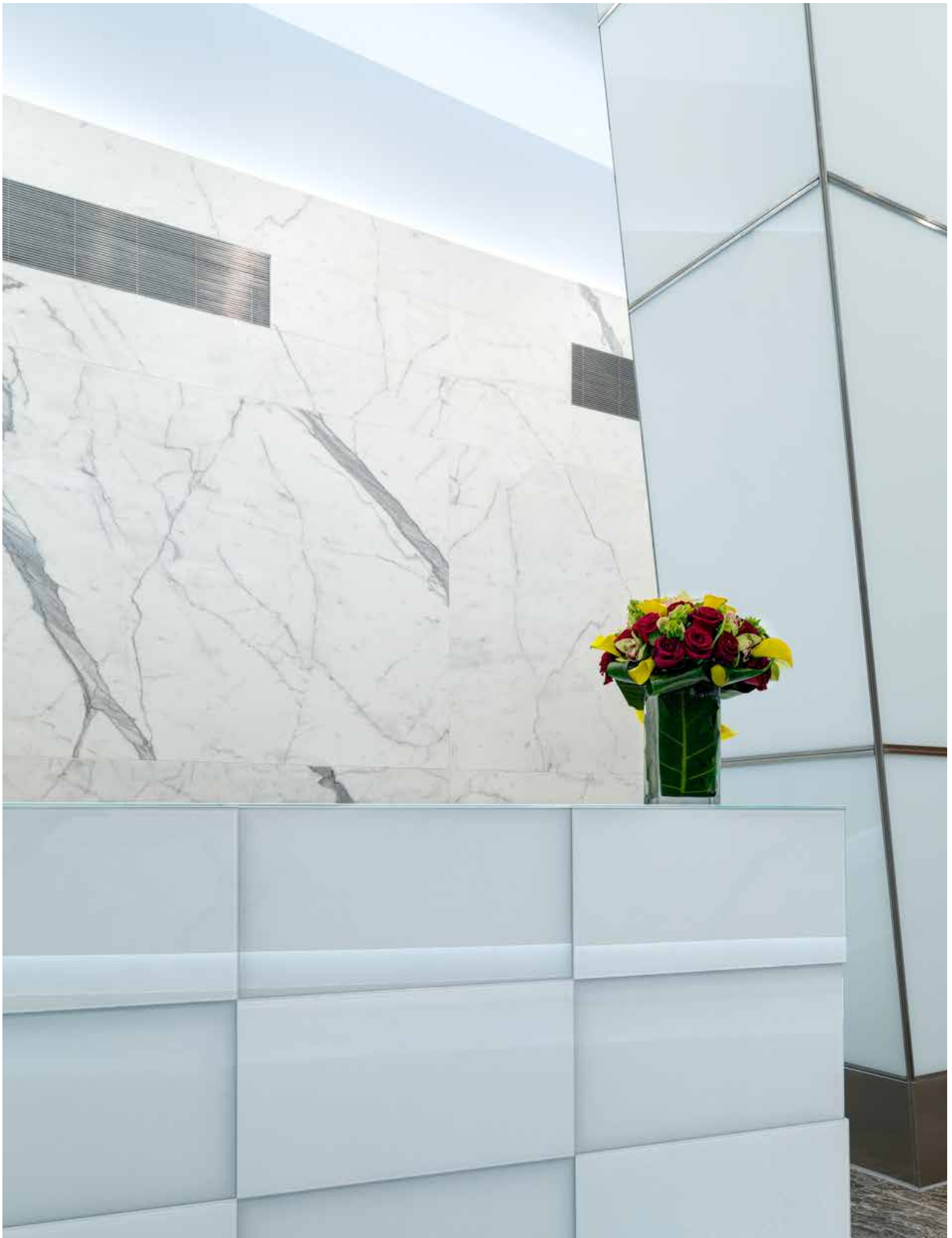



Wall_Marmi Extra White_Marmi Black Venato
Floor_Marmi Extra White_Marmi Black Venato
Vanity top_Marmi Black Venato
Furniture_Marmi Extra White_Marmi Black Venato
Stairs_Marmi Black Venato





Floor_Marmi Stone Grey
Furniture_Marmi Statuario Light





Wall_Marmi Arabescato
Floor_Marmi Arabescato
Furniture_Marmi Arabescato





Wall_ Marmi Blue de Savoie_ Marmi Black Venato
Floor_ Marmi Bianco Venato Extra
Furniture_ Marmi Bianco Venato Extra_ Marmi Black Venato





Floor_Wall_Maxfine Marmi Eramosa_Onice Oro
Furniture_Maxfine Marmi Eramosa_Onice Oro





Wall_Onice Oro
Wall_Onice Perla
Floor_Onice Perla

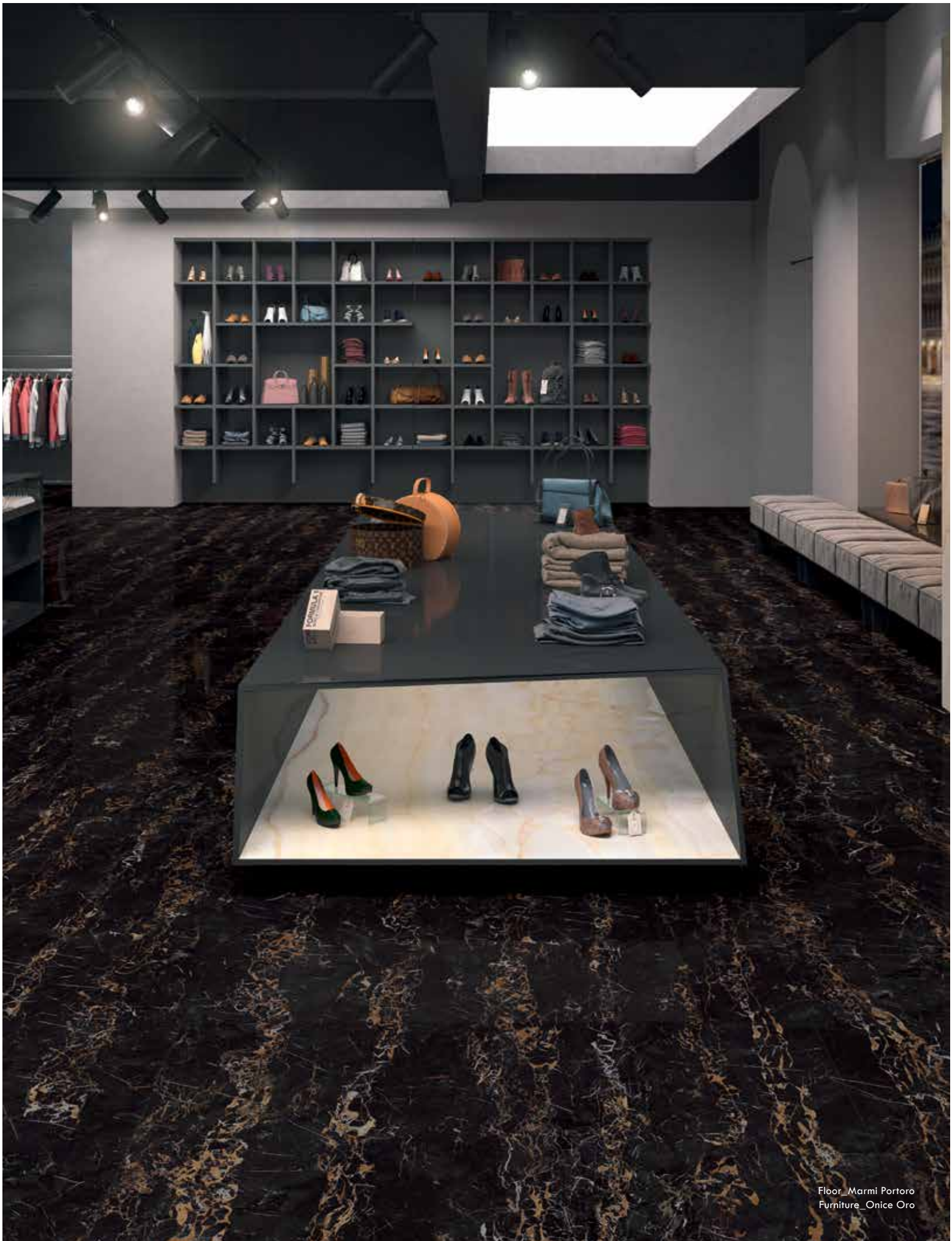



Floor_Pietre Lavica Dark
Furniture_Travertino Classico



Wall_ Maxfine Pietre Lavica Dark
Floor_ Maxfine Pietre Lavica Dark



Wall_Marmi Statuario Light
Floor_Citystone Grey
Furniture_Marmi Statuario Light





Wall Cladding_Marmi Bianco Lasa_Limestone Ash
Floor_Limestone Ash





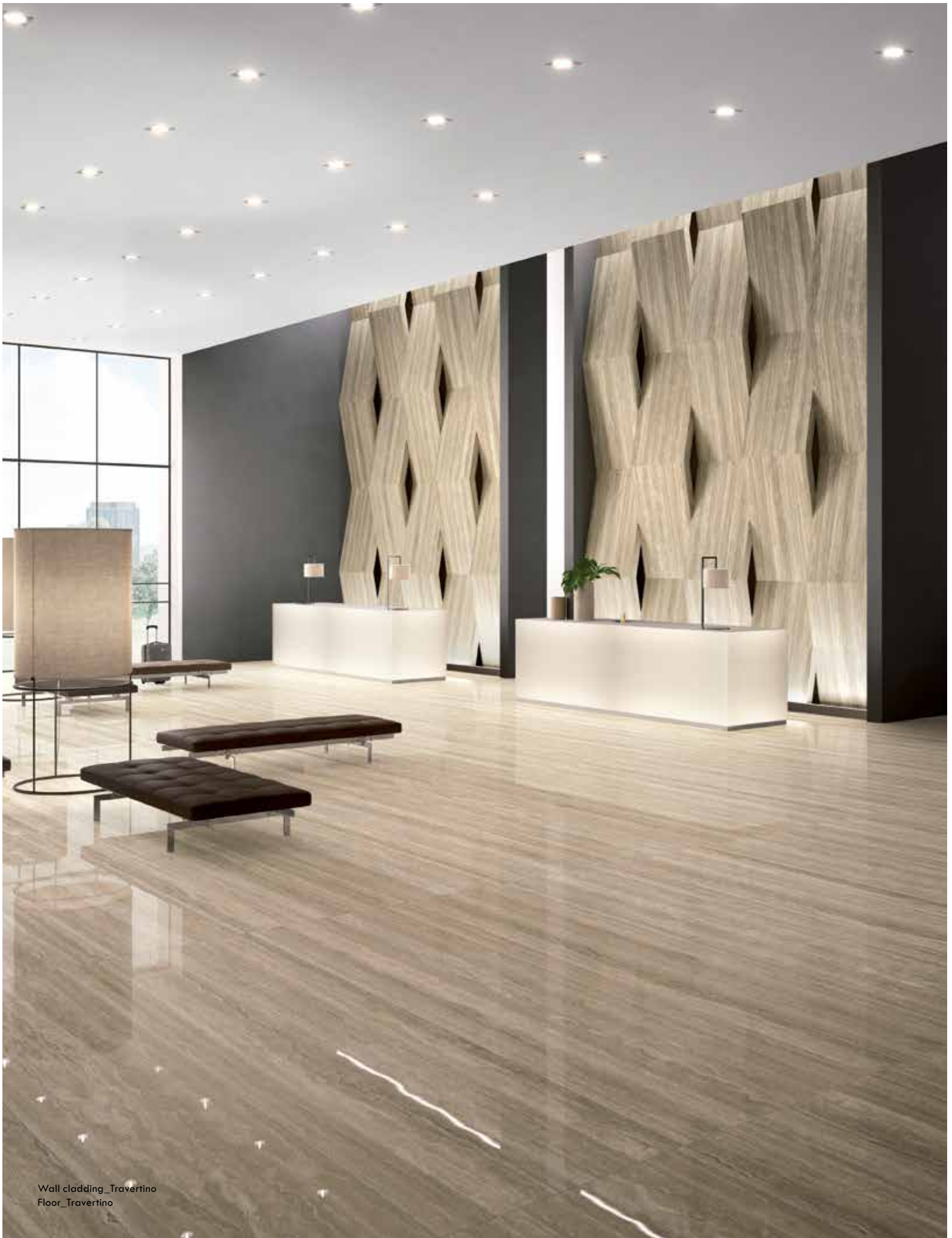

Wall cladding_Travertino
Floor_Travertino



Floor_Travertino



Floor_Iron Grey
Fireplace_Table_Iron Black



Marble inspiration

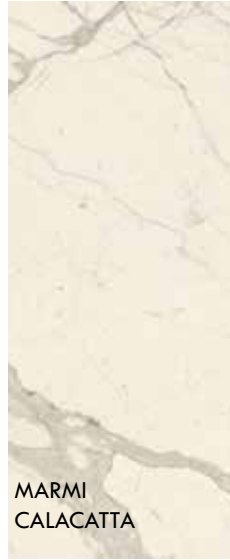

MAXFINE offers a very rich variety of textural effects so as to always find the right uncompromising inspiration.

Each material is a prototype of beauty: marble, onyx, metal, stone, wood, and concrete.



Stone inspiration

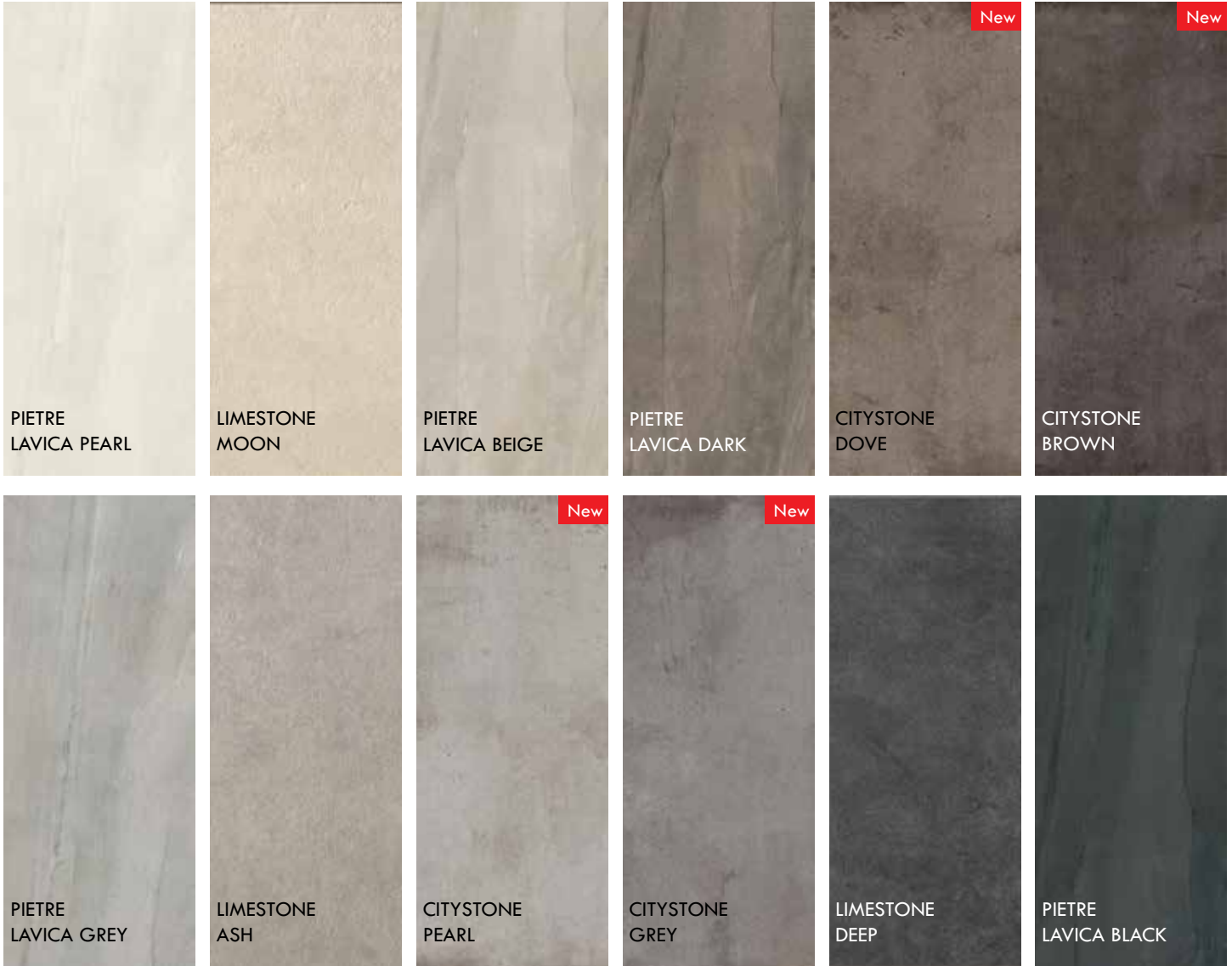

Large-size slabs and modular formats for any flooring or wall, but also for dressing a design. With **MAXFINE** everything can be made: from the walls of a skyscraper to a garden table.

Iron inspiration



Cement inspiration

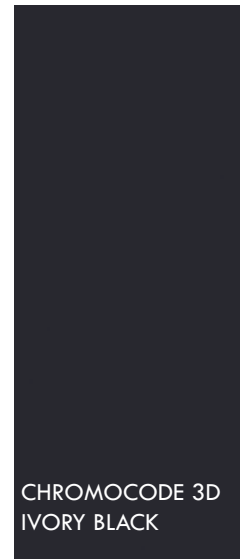
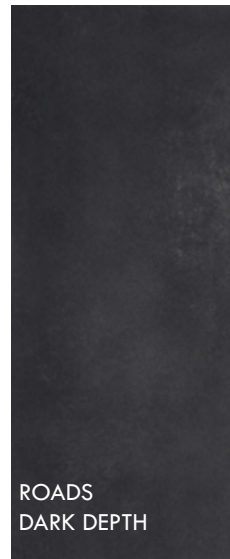
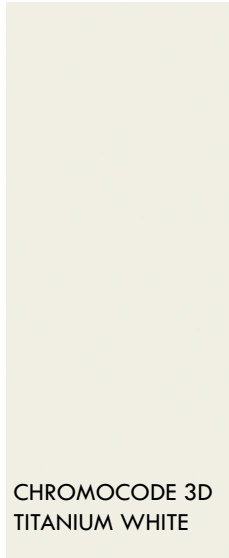

Calacatta Bookmatch



A

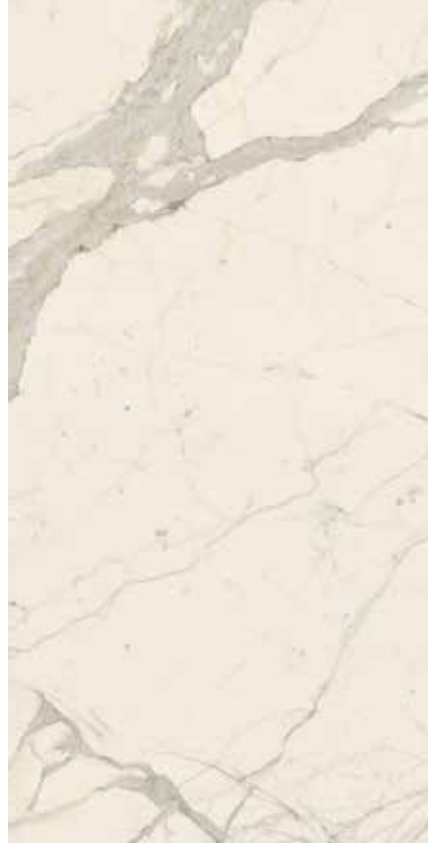

B

Bianco Venato Extra Bookmatch



A



B

Arabescato Bookmatch



A



B

Extra White Bookmatch



A



B







128" x 64"*

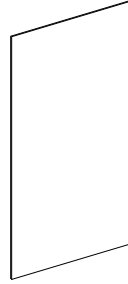

120" x 60"



120" x 40"

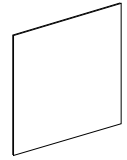

60" x 60"

Marble inspiration  6 MM

MARM STATUARIO LIGHT	LU	*	L315334MF6	-	L150334MF6
MARM ARABESCATO LIGHT	LU	*	L315333MF6	-	L150333MF6
MARM GAUDI STONE	LU	*	L315336MF6	-	L150336MF6
	PL	*	P315336MF6	-	P150336MF6
MARM STONE GREY	LU	*	L315335MF6	-	L150335MF6
	PL	*	P315335MF6	-	P150335MF6
MARM PORTORO	LU	*	L315337MF6	-	L150337MF6
MARM ESTREMOZ CREMA	LU	*	L315316MF6	-	L150316MF6
	PL	*	P315316MF6	-	P150316MF6
MARM CALACATTA	LU	*	L315265MF6	L310265MF6	L150265MF6
	PL	*	P315265MF6	P310265MF6	P150265MF6
MARM CALACATTA BLOCK-A	LU	*	L315268MF6	-	-
	PL	*	P315268MF6	-	-
MARM CALACATTA BLOCK-B	LU	*	L315267MF6	-	-
	PL	*	P315267MF6	-	-
MARM ALPS HEART	LU	*	L315297MF6	-	L150297MF6
	PL	*	P315297MF6	-	P150297MF6
MARM CREMA MARFIL EXTRA	LU	*	L315298MF6	L310298MF6	L150298MF6
	PL	*	P315298MF6	P310298MF6	P150298MF6
MARM ERAMOSIA	LU	*	L315315MF6	-	L150315MF6
MARM THASSOS	LU	*	L315189MF6	L310189MF6	L150189MF6
	PL	*	P315189MF6	P310189MF6	P150189MF6
MARM BIANCO LASA	LU	*	L315326MF6	-	L150326MF6
	PL	*	P315326MF6	-	P150326MF6

* Available upon request.

 10 MM Available upon request.

/ Sizes Available

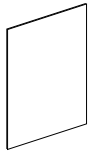

60" x 40"



60" x 30"

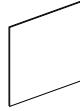

40" x 40"



30" x 30"



30" x 15"



-	L175334MF6	-	L75334MF6	L737334MF6
-	L175333MF6	-	L75333MF6	L737333MF6
-	L175336MF6	-	L75336MF6	L737336MF6
-	P175336MF6	-	P75336MF6	P737336MF6
-	L175335MF6	-	L75335MF6	L737335MF6
-	P175335MF6	-	P75335MF6	P737335MF6
-	L175337MF6	-	L75337MF6	L737337MF6
-	L175316MF6	-	L75316MF6	L737316MF6
-	P175316MF6	-	P75316MF6	P737316MF6
L1510265MF6	L175265MF6	L100265MF6	L75265MF6	L737265MF6
P1510265MF6	P175265MF6	P100265MF6	P75265MF6	P737265MF6
-	-	-	-	-
-	-	-	-	-
-	-	-	-	-
-	-	-	-	-
-	L175297MF6	-	L75297MF6	L737297MF6
-	P175297MF6	-	P75297MF6	P737297MF6
L1510298MF6	L175298MF6	L100298MF6	L75298MF6	L737298MF6
P1510298MF6	P175298MF6	P100298MF6	P75298MF6	P737298MF6
-	L175315MF6	-	-	-
L1510189MF6	L175189MF6	L100189MF6	L75189MF6	L737189MF6
P1510189MF6	P175189MF6	P100189MF6	P75189MF6	P737189MF6
-	L175326MF6	-	L75326MF6	L737326MF6
-	P175326MF6	-	P75326MF6	P737326MF6

* Available upon request.

 10 MM Available upon request.



128" x 64"*

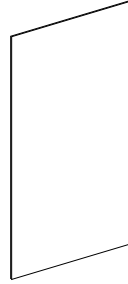

120" x 60"



120" x 40"

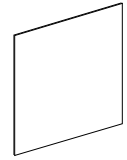

60" x 60"

Marble inspiration  6 MM

MARMİ BIANCO VENATO EXTRA	LU	*	L315300MF6	-	L150300MF6
	PL	*	P315300MF6	-	P150300MF6
MARMİ BIANCO VENATO EXTRA BLOCK-A	LU	*	L315301MF6	-	-
	PL	*	P315301MF6	-	-
MARMİ BIANCO VENATO EXTRA BLOCK-B	LU	*	L315302MF6	-	-
	PL	*	P315302MF6	-	-
MARMİ ARABESCATO	LU	*	-	-	L150320MF6
	PL	*	-	-	P150320MF6
MARMİ ARABESCATO BLOCK-A	LU	*	L315320MF6A	-	-
	PL	*	P315320MF6A	-	-
MARMİ ARABESCATO BLOCK-B	LU	*	L315320MF6B	-	-
	PL	*	P315320MF6B	-	-
MARMİ EXTRA WHITE	LU	*	L315317MF6	-	L150317MF6
	PL	*	P315317MF6	-	P150317MF6
MARMİ EXTRA WHITE BLOCK-A	LU	*	L315318MF6	-	-
	PL	*	P315318MF6	-	-
MARMİ EXTRA WHITE BLOCK-B	LU	*	L315319MF6	-	-
	PL	*	P315319MF6	-	-
MARMİ BLUE DE SAVOIE	LU	*	L315327MF6	-	L150327MF6
	PL	*	P315327MF6	-	P150327MF6
MARMİ BLACK VENATO	LU	*	L315314MF6	-	L150314MF6
ONICE PERLA	LU	*	L315290MF6	-	L150290MF6
	PL	*	P315290MF6	-	P150290MF6
ONICE ORO	LU	*	L315289MF6	-	L150289MF6
	PL	*	P315289MF6	-	P150289MF6
TRAVERTINO CLASSICO	LU	*	L315328MF6	-	L150328MF6
	PL	*	P315328MF6	-	P150328MF6
TRAVERTINO	LU	*	L315288MF6	-	L150288MF6
	PL	*	P315288MF6	-	P150288MF6

* Available upon request.

 10 MM Available upon request.

/ Sizes Available

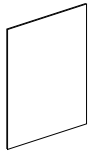

60" x 40"



60" x 30"

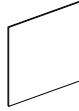

40" x 40"



30" x 30"



30" x 15"



-	L175300MF6	-	L75300MF6	L737300MF6
-	P175300MF6	-	P75300MF6	P737300MF6
-	-	-	-	-
-	-	-	-	-
-	-	-	-	-
-	-	-	-	-
-	L175320MF6	-	L75320MF6	L737320MF6
-	P175320MF6	-	P75320MF6	P737320MF6
-	-	-	-	-
-	-	-	-	-
-	-	-	-	-
-	-	-	-	-
-	L175317MF6	-	L75317MF6	L737317MF6
-	P175317MF6	-	P75317MF6	P737317MF6
-	-	-	-	-
-	-	-	-	-
-	-	-	-	-
-	-	-	-	-
-	L175327MF6	-	L75327MF6	L737327MF6
-	P175327MF6	-	P75327MF6	P737327MF6
-	L175314MF6	-	L75314MF6	L737314MF6
-	L175290MF6	-	L75290MF6	L737290MF6
-	P175290MF6	-	P75290MF6	P737290MF6
-	L175289MF6	-	L75289MF6	L737289MF6
-	P175289MF6	-	P75289MF6	P737289MF6
-	L175328MF6	-	L75328MF6	L737328MF6
-	P175328MF6	-	P75328MF6	P737328MF6
-	L175288MF6	-	L75288MF6	L737288MF6
-	P175288MF6	-	P75288MF6	P737288MF6

* Available upon request.

 10 MM Available upon request.



120" x 60"



120" x 40"

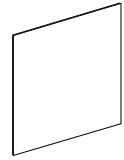

60" x 60"

Cement inspiration  6 MM

ROADS WHITE PURITY	N	P315197MF6	P310197MF6	P150197MF6
ROADS SAND HEARTH	N	P315198MF6	P310198MF6	P150198MF6
ROADS COFFEE TRUTH	N	P315199MF6	P310199MF6	P150199MF6
ROADS PEARL MIND	N	P315200MF6	-	P150200MF6
ROADS GREY CALM	N	P315201MF6	P310201MF6	P150201MF6
ROADS DARK DEPTH	N	P315202MF6	P310202MF6	P150202MF6
CHROMOCODE 3D TITANIUM WHITE	LU	L315240MF6	L310240MF6	L150240MF6
	N	P315240MF6	P310240MF6	P150240MF6
CHROMOCODE 3D IVORY BLACK	LU	L315247MF6	L310247MF6	L150247MF6
	N	P315247MF6	P310247MF6	P150247MF6

* Available upon request.

 10 MM Available upon request.

/ Sizes Available

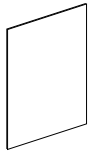

60" x 40"



60" x 30"

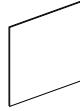

40" x 40"



30" x 30"



30" x 15"



P1510197MF6	P175197MF6	P100197MF6	P75197MF6	P737197MF6
P1510198MF6	P175198MF6	P100198MF6	P75198MF6	P737198MF6
P1510199MF6	P175199MF6	P100199MF6	P75199MF6	P737199MF6
-	P175200MF6	-	P75200MF6	P737200MF6
P1510201MF6	P175201MF6	P100201MF6	P75201MF6	P737201MF6
P1510202MF6	P175202MF6	P100202MF6	P75202MF6	P737202MF6
L1510240MF6	L175240MF6	L100240MF6	L757240MF6	L737240MF6
P1510240MF6	P175240MF6	P100240MF6	P757240MF6	P737240MF6
L1510247MF6	L175247MF6	L100247MF6	L757247MF6	L737247MF6
P1510247MF6	P175247MF6	P100247MF6	P757247MF6	P737247MF6

* Available upon request.

 10 MM Available upon request.

Stone inspiration

 6 MM



120" x 40"





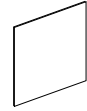

60" x 40"

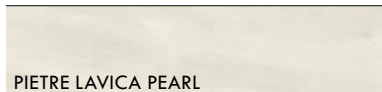

40" x 40"

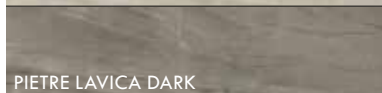
	N	P310333MF6	-	P100333MF6
CITYSTONE PEARL				
	N	P310334MF6	-	P100334MF6
CITYSTONE GREY				
	N	P310335MF6	-	P100335MF6
CITYSTONE DOVE				
	N	P310336MF6	-	P100336MF6
CITYSTONE BROWN				
	ST R10 A+B	P310311MF6	P1510311MF6	P100311MF6
LIMESTONE MOON				
	ST R10 A+B	P310312MF6	P1510312MF6	P100312MF6
LIMESTONE ASH				
	ST R10 A+B	P310313MF6	P1510313MF6	P100313MF6
LIMESTONE DEEP				

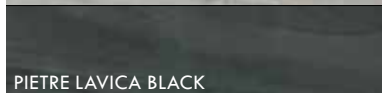
	PL	L310303MF6	-	L100303MF6
PIETRE LAVICA PEARL	N	P310303MF6	P1510303MF6	P100303MF6
	PL	L310306MF6	-	L100306MF6
PIETRE LAVICA BEIGE	N	P310306MF6	P1510306MF6	P100306MF6
	PL	L310305MF6	-	L100305MF6
PIETRE LAVICA DARK	N	P310305MF6	P1510305MF6	P100305MF6
	PL	L310304MF6	-	L100304MF6
PIETRE LAVICA GREY	N	P310304MF6	P1510304MF6	P100304MF6
	PL	L310307MF6	-	L100307MF6
PIETRE LAVICA BLACK	N	P310307MF6	P1510307MF6	P100307MF6

* Available upon request.

 10 MM Available upon request.

/ Sizes Available

Iron inspiration

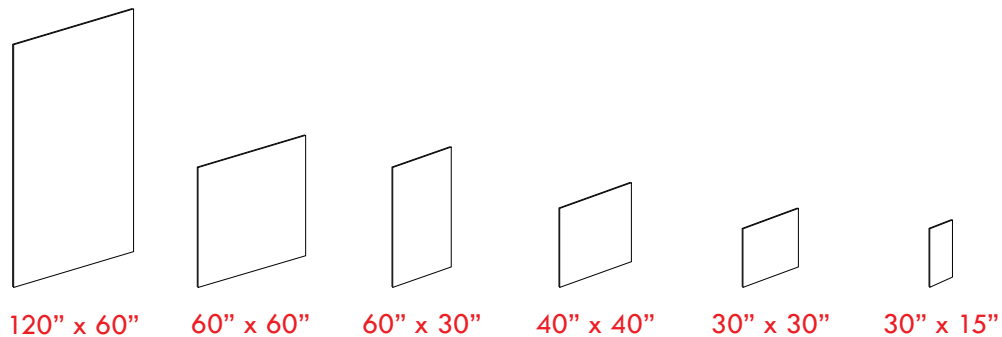

CORTEN	PL	L315276MF6	L150276MF6	L175276MF6	-	L75276MF6	L737276MF6
	N	P315276MF6	P150276MF6	P175276MF6	-	P75276MF6	P737276MF6
IRON BRONZE	N	P315330MF6	P150330MF6	P175330MF6	P100330MF6	P75330MF6	P737330MF6
IRON BLACK	N	P315329MF6	P150329MF6	P175329MF6	P100329MF6	P75329MF6	P737329MF6
IRON GREY	N	P315331MF6	P150331MF6	P175331MF6	P100331MF6	P75331MF6	P737331MF6

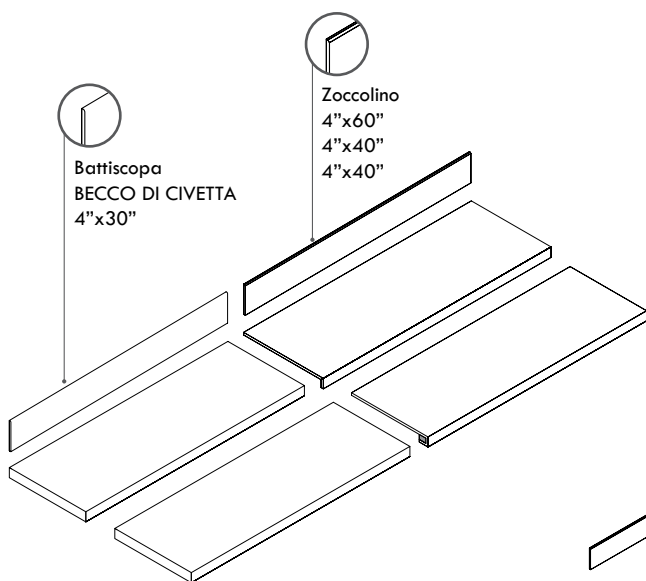

/ Trim pieces*

* Available upon request.

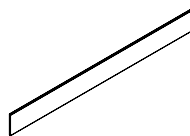

Zoccolino
4''x60''
4''x40''
4''x40''

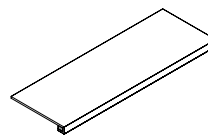

Scalino Costa retta
14''x60''x2''
14''x40''x2''

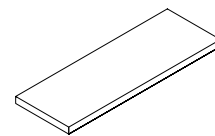

Angolo Scalino Costa retta
14''x60''x2''
14''x40''x2''

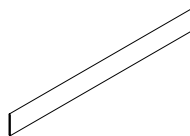

Battiscopa
BECCO DI CIVETTA
4''x30''

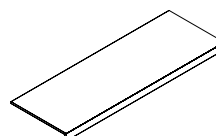

Scalino Bordo dritto
14''x60''x2''
14''x40''x2''

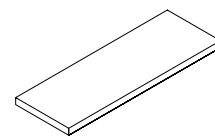

Angolo Scalino Bordo dritto
14''x60''x2''
14''x40''x2''

/ Limitations & Responsibilities

We have taken every care to provide complete information in this document; this information should be used as a guide in the design, installation and care of MAXFINE IRIS FMG large porcelain panels. No warranty however implied or expressed, is given in relation to the procedures outlined in this technical information guide except that is required by industry standards.

MAXFINE IRIS FMG / IRIS U.S. assumes that the designers, fabricators and installers using our large porcelain panels are familiar with all aspects outlined in the information provided, and strictly adhere to the recommendations and specifications described herein and by ANSI industry standards. Any deviation from the recommended guidelines may result in the products not performing as expected, and may result in the warranty becoming null and void. Though every care and precaution has been taken in the preparation of this document, MAXFINE IRIS FMG / IRIS U.S. assumes no responsibility for errors and/or omissions, or for the damages resulting from the use of instruction contained in the information hereby provided.

MAXFINE IRIS FMG / IRIS U.S. shall not be liable for any loss of profit or any other loss or damage caused or alleged to have been caused either directly or indirectly as a result of any person solely relying upon any information contained in this manual.

MAXFINE IRIS FMG / IRIS U.S. reserves the right to change or modify this manual or its electronic version from time to time without notice. It is the responsibility of the consumer to consult or contact MAXFINE IRIS FMG / IRIS U.S. for the latest version or updates.

/ General Instructions

Shipping	/ 52
Handling	/ 54
Tools Needed	/ 56
Manipulation Full Cuts, Cut Outs, & Mitered Edges	/ 57
Floor / Wall Installation	/ 60
Exterior Installation	/ 61
Countertop Fabrications	/ 61
Cleaning & Maintenance	/ 62
Recommended Cleaners	/ 62
Recommended Installation Accessories Tools Blades / Bits Building Products / Backerboards Adhesives (Colored Epoxy, Glue, etc.) Setting Materials (Thin Set, Grout, etc.) Trowels	/ 63
Factory Certified Training (F.A.C.T.)	/ 66
Quality Assurance	/ 67

PRODUCT IDENTIFICATION

- Each full crate will include a product sticker with the product description, shade, size, and code, along with a packing slip for details of shipment and material.
- All smaller shipments will only include the packing slip. If a special shade is needed, please indicate it on the purchase order. When ordering the same material multiple times, the same (original) shade cannot be guaranteed.



FOR ALL PANELS FROM 120" X 60" & 60" X 60", VERTICAL TRANSPORTATION IS PREFERRED BY USING A-FRAME PACKAGING:

- A-frame packaging can hold up to 50 pieces of 5'x10' porcelain panels vertically.
- Full 20 ft. containers hold 150 pieces (3 total A-frames).



OTHER SIZE PACKAGING:

- 15"x30", 30"x30", and 30"x60" are regularly packaged in a box and shipped in wood crates. 60"x60" are shipped flat in reinforced crates, holding 24 pieces per crate, or on a vertical A-frame holding up to 48 pieces.

WHEN TAKING DELIVERY OF LARGE PORCELAIN PANELS 120" X 60" & 60" X 60" PLEASE NOTE THE FOLLOWING:

- It is important to examine any shipment to notate any damage on BOL or a claim may be refused.
- If you detect any defect after taking delivery of the panels, and prior to cutting, do not proceed with the processing. Call your customer service or sales representative immediately.

We do not recommend using the same A-frame to ship with as that received from the factory.

- When uncrating the panels, always apply clamps on an A-frame before strapping band is cut from the crate.



- Use a forklift boom & pitch clamp to carefully move the panels from the original slim factory A-frame, to an A-frame with a wider base and more obtuse angle. We recommend padding the A-frame prior to placing the panels on to each of its sides.



- Use 3 straps to tie the panels to the A-frame, and wrap plastic around the entire A-frame 3X to prepare the package for shipment.





- For the correct handling of the pallets, a fork lift truck must be used, at least 8 ft. long, with the forks positioned in the largest width position.
- Under normal conditions, the forks are positioned in the middle of the long side of the pallet, as they must grip the whole depth of the pallet.
- To allow the loading or extraction of the slabs easily and safely, it is recommended to position the pallets in a suitable area where the lift truck can be moved around all sides of the pallet.



- On all LTL shipments (12 panels or less), always strap A-frames securely inside of a cab. Never clamp them.



- Pump Activated Suction cup handles are recommended to move a panel a short distance. Panel weight is approx. 140 lbs. and no more than 2 experienced people are suggested to move.

- To safely transport up to 8 slabs of 6mm from warehouse to job site we strongly recommend the use of a transporter. The transporter is also designed to store slabs on the job site.

See page 63 for recommended tool providers



- Make sure to use proper base support when standing a panel. The use of two support pieces about 2" thick and 24" from each end of the panel, or a solid base with protective cushioning is recommended.

PLEASE USE PROPER HANDLING TOOLS WHEN MOVING THE PANELS OR CRATES

- Forklift Extension *See page 54*
- Suction Cups *See page 55*
- Large Porcelain Panel Tile Transporter *See page 55*
- Forklift Boom & Pinch Clamp *See page 54*

See page 63-65 for recommended tool providers



OTHER HANDLING TOOLS NEEDED

- Rigid Working Table to Match the Dimension of the Panels 120" x 60" or larger *See photo above.*
- Scoring Tools *See page 57-59*
- Variable Speed Grinder With Electroplated Diamond Blades *See page 57*

LIST OF TOOLS & MATERIALS NEEDED FOR PORCELAIN PANEL INSTALLATION JOBS

- Tape measure
- Framing square
- Marking pencil / china marker
- Chalk line
- Grid (graph) paper
- Carpenter's triangle
- Safety glasses
- Safety gloves
- Knee pads
- Buckets
- Drill and mixing paddle
- Spray bottle
- Trowel specific to large panels
- 2 x 4
- Rubber mallet
- Sponges
- Abrasive stone
- Manual tile cutter
- Tile nipper
- Grout float
- Cheesecloth
- Tile spacer / Leveling system
- Water
- Thin-set mortar
- Grout
- Painter's tape
- Grout haze / film remover
- Grout sealer
- StainBlocker for grout
- Paper towels

- The “score and snap” is the preferred method for straight cuts (from one end of the panel to the other) using a recommended tool.

See page 63-65 for recommended tool providers



- When planning a cut that will be the full length of the panel, either with a plunge cut, or starting at the edge, mark and drill a relief hole at the termination point of the cut, then cut towards the relief hole. Properly support piece equally across entire surface of the piece when setting in mortar and prior to handling for installation.
- When planning a plunge cut, drill a relief hole with an electroplated core bit at the termination point of the cut, prior to beginning the cut. Always cut towards the relief hole.
- When planning a “U” shaped cut, mark, and drill relief holes where the cut lines will intersect. Always make the shortest cuts first, leaving your waste/dropout attached to the largest part of your desired piece for the final cut.
- When planning an “L” shaped cut, mark and drill relief holes where the cut lines will intersect, always cut the shortest length first, and cut towards the relief hole.

See page 58 for cutting diagram

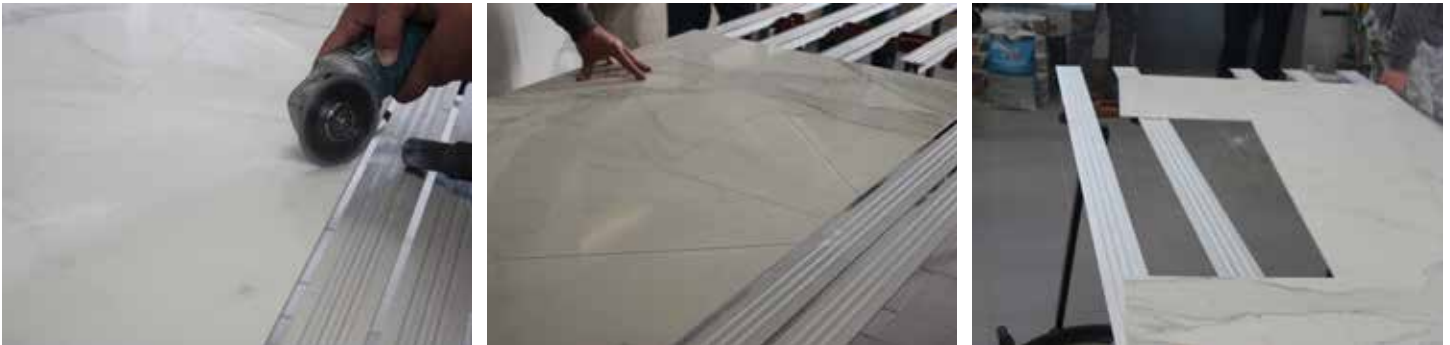

- When manipulating large porcelain panels, a variable speed right angle grinder is strongly suggested to reduce vibration. Electroplated diamond blades or electroplated diamond drill bits should be used for various cuts and manipulations.

See page 63-65 for recommended tool providers



IMPORTANT: Always cut towards the relief hole.



When cutting a “U” shaped piece, mark, and drill relief holes where the cut lines intersect. Always make the shortest cut first.

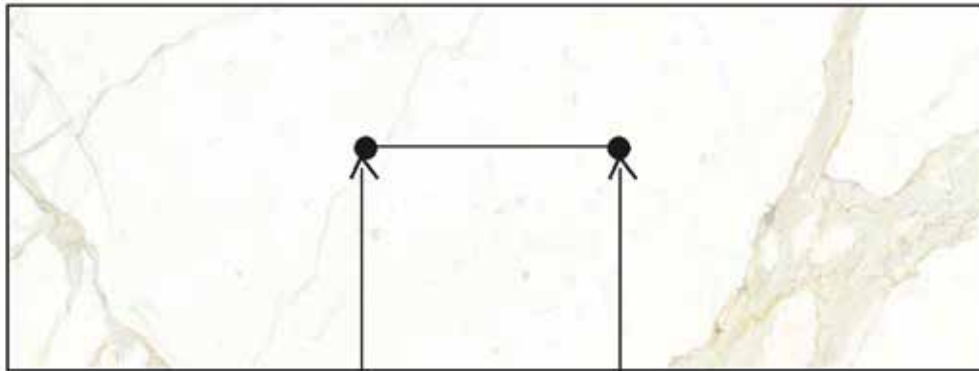

When cutting an “L” , drill relief holes where the cut lines intersect, always make the shortest cut first.

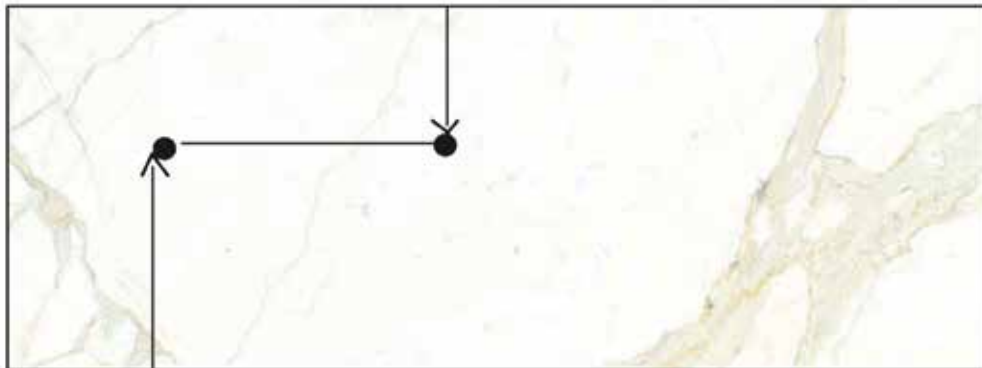

Color matched or tinted polyester, epoxy compounds or equivalent are often used to fill edges and bring the pieces together to form a smooth transition.



ALWAYS PROPERLY SUPPORT EACH PIECE PRIOR TO INSTALLATION.

- For circular cut outs, a circular electroplated diamond core bit must be used with a variable speed grinder or drill.

See page 63-65 for recommended tool providers



- For straight line cut outs, a variable speed grinder with electroplated diamond blades must be used. Relief holes or cuts before planning a square or rectangular shape are necessary.



- When possible, it is best to fabricate niches and holes after the panel is already installed with thin set on wall or floor. If it is not possible to cut holes or square/rectangular cuts (fireplace, sink, etc.) before the panel is installed, create full support with plywood or MDF panel template with same shapes and cuts to attach and transport the porcelain panel. Support panels should only be detached when porcelain panels are fully bonded to the substrate.

- It is also possible to move panels with proper moving tools made of multiple suction cups to avoid tension of the panel after it is cut.



- Material can be mitered using proper tools. Colored or tinted compounds such as polyester, epoxy, or equivalent are often used to fill edges and bring the 45 degree miter cuts together.

- Material can be bullnosed the same as regular porcelain.





- Large porcelain panels can be installed over concrete or other suitable substrates. You must honor all expansion joints or any defects in the substrate and mitigate prior to installation.
- Substrate should be a minimum of 1/4" over 10 feet in flatness.
- The back of the panel and substrate should be spread the same direction at the shortest distance with a modified LFT thin set mortar to achieve 100% coverage.

- Self-leveling systems are required to achieve desired flatness between joints. Fill any voids with the mortar for complete support.
- Recommended tools and techniques need to be used to ensure full bond of the panel. Recommended techniques should be followed to move air out from underneath the panels.
- The setting material manufacturers have vast experience in the installation of porcelain tiles and large porcelain panels. Accordingly, we strongly recommend that the installer should contact the relevant setting material manufacturers and seek their advice prior to installation of our large porcelain panels.

See referenced manufacturers page 63-65 for contact details.



See page 63 for recommended trowels

- It is very important to spread thin set the same direction on both the substrate and the panel, the shortest direction of panels. Thin set brands we recommend are: LFT by Mapei, ProLite by Custom, 254 Platinum by Laticrete, and x77 Walls & x78 Floors by Ardex Tec. See referenced manufacturers page 63-65 for contact details.



Example of proper full mortar coverage

- Place tile into the fresh mortar and firmly press to cause the ridges to flatten out and come together into a continuous void free bed. Install desired spacers/levelers of preferred grout joint design width.
 - Polymer added sanded and unsanded grout, epoxy grout, silicone, or polyurethane can be used to fill the joints. If using epoxy grout, make sure to follow proper cleaning instruction within the manufacturers' specific time frame.
- NOTE: Recommended 1/8" grout joint width should be maintained throughout the entire installation. Countertop seams can be butted.

Iris U.S./Maxfine does not accept any responsibility nor does it recommend a particular method of installation. It is the responsibility of the installer/buyer to design the tiling system based on the advice obtained from the setting material manufacturer.

- Large porcelain panels are ideal for exterior cladding of walls and vertical applications.
- We offer mechanical and bonded techniques.

Contact manufacturer for further information or to become a certified installer.



/ Countertop Fabrications

- Large porcelain panels are ideal for countertop installation with the proper substrate.

Contact manufacturer for further information or to become a certified installer.



FIRST CLEANING POST INSTALLATION

A PROPER INITIAL CLEANING AFTER INSTALLATION IS SUGGESTED.

PROFESSIONAL CLEANERS SHOULD BE USED TO MAKE SURE ALL CONSTRUCTION

RESIDUES ARE COMPLETELY REMOVED. *(See below for recommended professional cleaners.)*

CLEANING DURING INSTALLATION

Construction particles, dust, sand, and debris should be removed from the panel surface by sweeping with a soft brush.

Sand and other abrasive materials may scratch the floor, therefore the surfaces should always be kept free from dust, sand, and soil.

MAXFINE large porcelain panel surfaces should be properly covered and protected after the installation, and up to the completion of all construction.

ORDINARY MAINTENANCE

Large porcelain panels are a high quality, solid, nonporous product that

require minimum maintenance. *(For daily maintenance, see below for recommended household cleaners.)*

RECOMMENDED CLEANERS FOR PROFESSIONAL USE**FILA CLEANING SOLUTIONS**

FILA

10800 N.W. 21st Street #170

Miami, FL 33172

Phone 305.724.8939

Website www.filasolutions.com

For organic residue removal

FILA PS87

For cement-based residue removal

FILA DETERDEK

For epoxy removal

FILA CR10

AQUA MIX

AQUA MIX

7711 Center Ave Ste 500

Huntington Beach, CA 92647

TF 800-272-8786

www.aquamix.com

HILLYARD, INC.

HILLYARD, INC.

302 North 4th Street

St. Joseph, MO 64501

TF 800.365.1555

Fax 800.861.0256

Website www.hillyard.com

For lead or metal residue removal

For contractor pencil marks

For removal of metal marks

Crème Clean

RECOMMENDED CLEANERS FOR DAILY USE**HOUSEHOLD CLEANERS**

Magic Eraser

Melamine Pad

Brasso Gel

Lysol Gel

All purpose ceramic cleaner

Windex

Baking Soda

Ammonia

TOOLS

RUSSO TRADING COMPANY INC

RUSSO TRADING COMPANY, INC.
4235 N 127th St.
Brookfield, WI 53005
Phone 855.782.8665
Fax 262.790.2177
www.RTCproducts.com

OMEGA DIAMOND INC

OMEGA DIAMOND INC.
10125 Ophir Road
Newcastle, CA 95658
Phone 888.996.4777
Fax 530.885.3785
www.omegadiamond.com

ABACO MACHINES USA (BOOM, PINCH CLAMP)

ABACO MACHINES USA
14508 S Garfield Ave
Paramount, CA 90723
Phone 310.532.0366
Fax 310.532.0499
www.abacomachines.com

PREMIUM NOTCH TROWEL BY SUPERIOR BILT

PREMIUM NOTCH TROWEL BY SUPERIOR BILT
7711 Center Ave Ste 500
Huntington Beach, CA 92647
TF 800.272.8786
Phone 562.598.8808
Fax 800.200.7765
www.custombuildingproducts.com

SIGMA / ETM TOOLS

European Tile Masters, Inc.
27 Copper Ridge Rd
Trout Creek, MT. 59874
Phone 954.917.3599
Fax 954.917.3539
Website www.europeantilemasters.com
www.toolsfortile.com

RAIMONDI TOOLS

Donnelly Distribution LLC
N 56 W 24790 N Corporate Circle Unit A
Sussex, WI 53089
TF 800.625.6686
Phone 262.820.1212
Fax 262.820.1226
www.donnelydist.com

TROWELS

FLOW RIDGE TROWEL BY RAIMONDI

DONNELLY DISTRIBUTION LLC
N63 W 22611 Main Street Unit C
Sussex, WI 53089
TF 800.625.6686
Phone 262.820.1212
Fax 262.820.1226
www.raimondiusa.com

EURO NOTCH TROWEL BY ETM

EUROPEAN TILE MASTERS, INC.
1830 Vista Way
Margate, FL 33063
Phone 954.917.3599
Fax 954.917.3539
www.europeantilemasters.com
www.toolsfortile.com

BLADES/BITS**CYCLONE**

DIAMAX INDUSTRIES
949 W Marietta St X100
Atlanta, GA 30318
Phone 404.817.3232
www.diamaxinc.com

WEHA

WEHA USA
625 Griffith Rd Suite 120
Charlotte, NC 28217
Phone 704.940.0115
www.wehaus.com

BUILDING PRODUCTS**WEDI BOARD**

WEDI Corporation
171 S Gary Ave
Carol Stream, IL 60188
Phone 877.933.wedi (9334)
Fax 847.357.9819
www.wedicorp.com

SCHLUTER SYSTEMS (KERDI BOARD)

SCHLUTER SYSTEMS L.P.
194 Pleasant Ridge Road
Plattsburgh, NY 12901-5841
TF 800.472.4588
Fax 800.477.9783
www.schluter.com

USG (CEMENT BOARD)

USG US Corporate Office
550 West Adams Street
Chicago, IL 60661
Phone 312.436.4000
www.usg.com

HARDIEBACKER BOARD

Available at most local hardware stores

ADHESIVES (COLORED EPOXY GLUE, ETC.)**AKEMI**

INNOCHEM
Innovative Chemicals
4030 Pleasantdale Road Suite F
Doraville, GA 30340
Phone 770.409.8789
Fax 770.409.9096
www.akemina.com

TENAX

TENAX USA
625 Griffith Rd Suite 120
Charlotte, NC 28217
Phone 704.583.1173
www.tenax4you.com

SETTING MATERIALS (THIN SET, GROUT, ETC.)

BOSTIK

BOSTIK, INC.
11320 W Watertown Plank Road
Wauwatosa, WI 53226
TF 800.762.7845
www.bostik-us.com

ARDEX

ARDEX Americas
400 Ardex Park Drive
Aliquippa, PA 15001
Phone 888.512.7339
www.ardexamericas.com

TEC

H.B. FULLER CONSTRUCTION PROJECTS INC.
1105 S Frontenac Street
Aurora, IL 60504
TF 800.552.6225
Phone 562.598.8808
www.tecspecialty.com

MAPEI

MAPEI Americas Headquarters
1144 E. Newport Center Drive
Deerfield Beach, FL 33442
TF 800.992.6273
Fax 954.246.8805
www.mapei.us

LATICRETE

LATICRETE International, Inc.
One LATICRETE Park North
Bethany, CT 06524-3423 USA
TF 800.243.4788
www.laticrete.com

CUSTOM BUILDING PRODUCTS

CUSTOM BUILDING PRODUCTS
7711 Center Ave Ste 500
Huntington Beach, CA 92647
TF 800.272.8786
Phone 562.598.8808
Fax 800.200.7765
www.custombuildingproducts.com

GET CERTIFIED NOW!



FACTORY ADVANCED CERTIFIED TRAINING

is implemented in our TN manufacturing facility by experts knowledgeable with MaxFine.

Participants learn how to handle, fabricate, and install our large porcelain panels for interior, exterior, floor, and wall applications. Upon completion and passing of our testing, they are then certified. Most importantly, participants obtain knowledge and hands on experience!

Please contact FACT@irisus.com for further information, or to participate in a training session.



PRODUCT	SIZE (IN.)	BOX PIECES	BOX SF	PALLET BOXES	PALLET SF	THICKNESS (MM)	WEIGHT LB/Box
Large Porcelain Panel	120 x 60	1	48.44	12	581.256	6	139.4604
	120 x 40	1	32.29	16	516.672	6	92.97357
	60 x 60	1	24.22	24	581.256	6	69.72907
	60 x 40	1	16.14	40	645.6	6	46.512
	60 x 30	2	24.22	25	605.475	6	69.72907
	40 x 40	2	21.53	20	430.56	6	61.98238
	30 x 30	3	18.16	36	654.107	6	52.29736
	30 x 15	6	18.16	36	654.107	6	52.29736

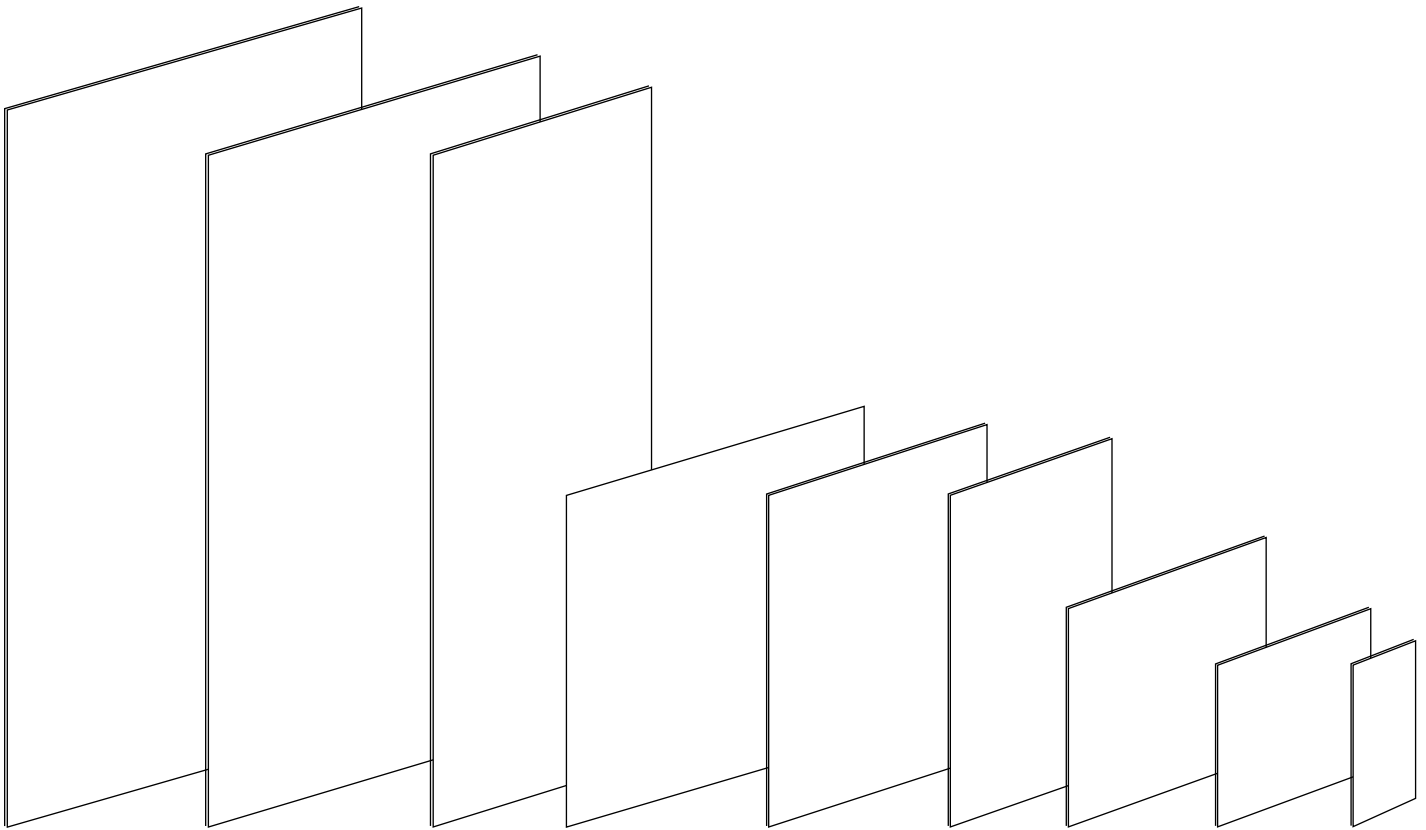

128" x 64"* 120" x 60" 120" x 40" 60" x 60" 60" x 40" 60" x 30" 40" x 40" 30" x 30" 30" x 15"

*Available upon request.

FULL-BODY MANUFACTURED NATURAL STONES WITH PORCELAIN TECHNICAL FEATURES

PHYSICAL - VISUAL PROPERTIES	ASTM TEST	INDUSTRY STANDARD	IRIS RESULTS
Water Absorption	C373	< 0.5%	< 0.1%
Thickness Dimension	C499	Range \pm 0.04 Inc. Max.	$\leq \pm$ 0.04 Inc.
Facial Dimension	C499	\pm 0.025%	$\leq \pm$ 0.025%
Warpage Average Diagonal	C485	\pm 0.40%	$\leq \pm$ 0.40%
Warpage Average Edge	C485	\pm 0.40%	$\leq \pm$ 0.40%
Wedging	C502	\pm 0.25%	$\leq \pm$ 0.25%
Bond Strength	C482	\geq 0.50 psi	\geq 0.200 psi
Breaking Strength	C648	\geq 250 lb.	\geq 350 lb.
Hardness (Mohs)	Scratch Test (No Regulation)	Range 0 - 10	\geq 7
Visible Abrasion Resistance for Glazed Tiles	C1027	No Requirement Range 0 - 5	Class 3 - 4
Deep Abrasion Resistance for Un-Glazed Tiles	C1243	Impervious (Porcelain) Class P1: \leq 175 mm	\leq 175 mm
Frost Resistance	C1026	No sample must show alterations to the surfaces	No evidence of damage
Chemical Resistance	C650	No Requirement Range E - A	Class A
Stain Resistance	C1378	No Requirement Range E - A	Class A*
DCOF	BOT 3000	\geq 0.42*	\geq 0.42 - \geq 0.60*
Aesthetic Classification	Visual Evaluation Shade & Texture	No Requirement Range V0 - V4	V2 - V3
Robinson Test	AC627	Classified as "Extra Heavy"	

* All values are given for Matte or Honed Material.